

Shanghai Mitsubishi Elevator Co., Ltd.

Address: No. 811 Jiangchuan Road, Minhang, Shanghai, China

Tel : +86-21-24083030/64303030

Fax : +86-21-24083088

Post: 200245

Overseas Business

Tel : +86-21-24083482

Fax : +86-21-24083488

e-mail : overseasbiz@smec-cn.com



www.smeccn.com



Specifications subject to change without notice
Printed in Oct. 2013 (GB-E)

Series C
— Moving Walk —

Series C Moving Walk

C系列自动人行道

With the use of up-to-date technology, series C moving walk are fast, comfortable and safe. They not only can meet the ever increasing needs for passengers' traffic in modern cities, but also bring one after another bright flowing scenic line to city buildings.

This is a relaxed space in busy cities and it can provide an ongoing step of taking a rest to townspeople walking in a hurry. No matter when they are walking with a handcart or with a big bundle of articles, also no matter who is old or holds a baby in the arms, all of them can make a relaxed and fast movement by riding a moving walk, feeling that outgoing, shopping and sightseeing are all a kind of real easy thing.

General

Safety and Energy-Saving Devices 3-4

Electric and Maintenance System 5-6

Design

Advantages and Merits are Everywhere 7-8

Type CS-LB/CS-LBF Type CS-SB/CS-SBF

Design

Decoration Configuration
Configuration of Safety Device 9-10

Specification Data

Feature List 11-12

Civil 13-18

Basic Specification 19-20

Safety and Energy-Saving Devices

Safety

A series of safety protective devices have been installed in series C moving walk to assure the highest safety under operation. The control cabinet and operation panel, which can be used to control the starting and braking, are set up in the electrical part to cut off the power supply by the control circuit when any abnormality of operation happens. The computer board is adopted in the electrical control system, which has such features as abnormal speed detection of passenger conveyor and its handrails, oiling control, etc., as well as failure display.

Energy Saving

High-efficiency helical gear reducer and new-type handrail driving device are adopted in the series C moving walk and the energy consumption can be saved. Passenger detecting devices are installed at two ends of entrance of moving walk for variable frequency to realize the feature of auto start and auto stop.

Comfortable

An advanced drive unit and reliable safety devices are installed in the series C moving walk, and moreover, a series of damping and anti-noise structures are used to make passengers feel comfortable, smooth and quiet during riding operation.



Large Transport Capacity

Series C moving walk have a large transport capacity. Series C moving walk can meet the requirements for modern passengers traffic of different aspects and they are suitable to many places such as airport, shopping center, hotel and recreational facilities, etc...

The space requirement for our unique creative design of moving walk has been reduced to the minimum. The sturdy structure can assure a large sufficient capacity. Every valuable space shall be saved and the requirements of modern city traffic shall be taken into full account while carrying the busy stream of people in large markets or airports.

The inclination angle of 0-12 degrees is available to option in accordance with different usage and environment.

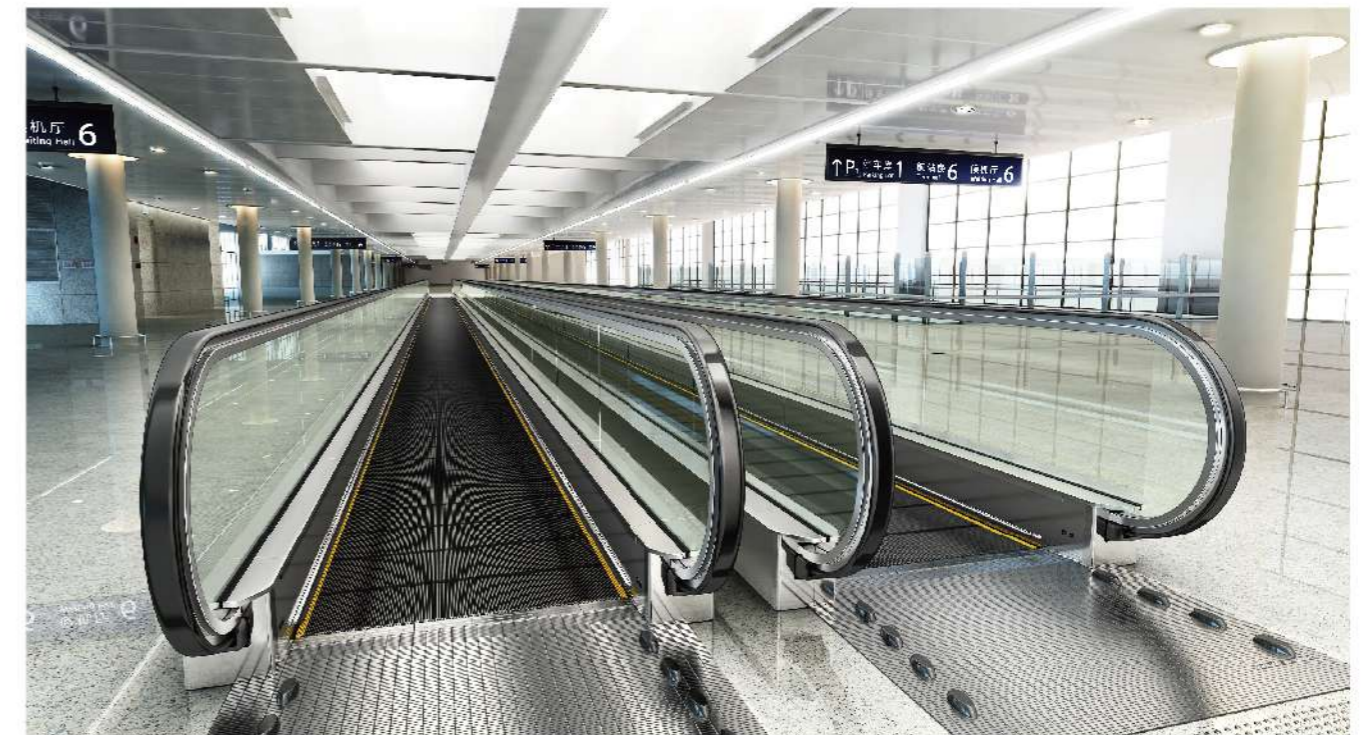

Electric and Maintenance System



Longer Component Lifespan

The lifespan of high-precision helical gear reduce will reach 20 years; The linear handrail drive significantly increase the lifespan of handrail; The unloading guides at the cured track of moving walk enable the rollers not in touch with the guide rail at upper cured part, reduces the wheel load and abrasion of the rollers, and prolongs the lifespan of the rollers; Using the automatic oil feeding device as the standard configuration significantly increase the lifespan of various chains; The standard interior-decorating components are made of stainless steel and are able to stand wear and tear.

Simple and Convenient Maintenance

The driving device of vertical layout has larger maintenance space than the driving device of horizontal layout, making the operation more convenient; Automatic oil feeding device adopted as the standard configuration. The moving walk uses a large number of chains, such as pallet chains, drive chains, handrail chain. The lubrication of these chains is essential for ensuring their lifespan and guaranteeing the performance and quality of the moving walk.

Advanced Electric System

With high-performance microprocessor adopted, the management, control, driving and communication of the moving walk are all integrated on one printed board, realizing the integrated design of the electrical system of moving walk; The self-developed technology of variable-pressure and frequency control realizes the current minimization control of electric motor, reduces the heating of IPM frequency components and improves the ability of the control screen to endure the environment of overheating; Modular design is adopted, realizing convenient expansion of the system.

Elegant and Exquisite Design and Decoration



As a kind of modern means of transportation which incarnates the elegant appearance of city, most of moving walk are installed in the thriving places of town. Series C moving walk designed according to high criterion have a wide range of optional decorations which can add luster to the city life in different places.



Type CS-LB / CS-LBF (with lighting)

The handrail down lighting of type CS-LB/CS-LBF moving walk creates a magnificent space, and its peaceful and smooth light can further serve as a foil to the elegant making of installation places of our moving walks.



Type CS-SB / CS-SBF

Super-slim handrail guides made of stainless steel are adopted in the CS-SB/CS-SBF moving walk and their structure is very compact, making passengers have a feeling that the handrails are sliding on glass. moving walk of this kind with succinct and sprightly outline have strong adaptability to environment and add luster



Decoration Configuration and Configuration of Safety Device

Lighting



Standard
Handrail Illumination(CS-LB/CS-LBF)

Handrail Guide Rail



Standard
Hairline stainless steel

Pallet

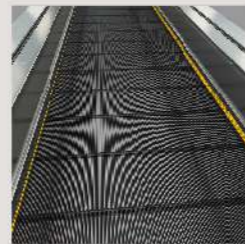

Standard
Aluminum alloy casting step with black painting

Front Plate

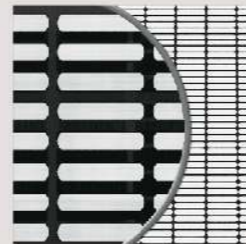

Standard
Stainless steel with anti-skid grooves and black coating inside.

Cover Plates



Standard
Hairline stainless steel

Step Demarcation Cleat

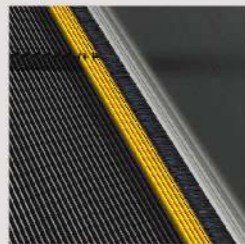

Standard
Yellow molded resin on left and right side of step.

Comb

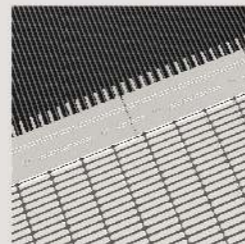

Standard
Aluminum Alloy

Operations Indicator



No.001
Black (Standard)



No.501
Char Grey (Optional)



No.503
Red (Optional)



No.506
Blue (Optional)



No.507
Gray (Optional)



Drive Chain Safety Device (DCS)

Once drive chains are broken, this device shall cut off the power supply of motor and brake and at the same time the drive ratchet shall stop the operation of passenger conveyor.

Handrail safety device (HSS)

When the handrail speed is lower than 15% of the pallet speed and maintains for over 15 seconds, this device will immediately cut off the power supply of the drive motor and the brake.

Handrail Inlet Safety Device (HGS)

This protective cover made of rubber is wrapped in a wrinkled skin to prevent hands from being drawn into inlet, and thus, our moving walk are more safe for children.

Emergency Stop Button (E-STOP)

Once this button is pressed, the moving walk comes into an emergency stop.

Over speed Governor 1

When running speed exceeds 1.2 times of nominal speed; this device will work and cut off power supply to main drive unit and working brake.

Over speed Governor 2

When running speed exceeds 1.4 times of nominal speed; this device will work and cut off power supply to auxiliary brake.(HT>6m)

Pallet Chain Safety Device (PCS)

Once the Pallet is abnormally extended or broken. This device shall cut off power supply of motor and brake.

Handrail Inlet Safety Device (HGS)

This protective cover made of rubber is wrapped in a wrinkled skin to prevent hands from being drawn into inlet, and thus, our moving walk are more safe for children.

Emergency Stop Button (E-STOP)

Once this button is pressed, the moving walk comes into an emergency stop.

Protection Against Phase Error and Loss

When input dynamic power source has any phase error or loss, cut off the main circuit and control circuit.

Comb Plates Safety Device (CSS)

If any foreign matter is caught between combs and treads, this device shall cut off the power supply of driving motor and brake.

Pallet Roller safety device (PRS)

If any one of step axles is broken, resulting that the tread of upper or bottom landing and the relative combs can not mesh normally, this device shall cut off the power supply of driving motor and brake.

Feature	Description	Code	Non-frequency Conversion	Frequency Conversion
■ Control and Security Features				
Phase Dislocation/ Phase Loss Protection	In case of phase dislocation or phase loss of the input power supply, cut the main circuit and control the circuit to stop the moving walk.	3E	Ⓢ	Ⓢ
Non-manipulated Reversion Protection	In case of moving walk reversion of the escalator, the device will cut down the power supply to the main drive motor and the brake.	ARP	Ⓢ	Ⓢ
Auxiliary Brake	When the moving walk reaches 1.4 times of the rated speed or is not operating in the required direction, the auxiliary brake stops the escalator.	AUX-BK *1	Ⓢ	Ⓢ
Auxiliary Brake	When the moving walk reaches 1.4 times of the rated speed or is not operating in the required direction, the auxiliary brake stops the escalator.	AUX-BK *2	Ⓞ	Ⓞ
Detection of Service Brake Actions	Stop the moving walk when the service brake cannot release or brake normally.	BLR	Ⓢ	Ⓢ
Service Brake	The service brake takes action to stop the moving walk, and keep it stopped.	BRK	Ⓢ	Ⓢ
Comb Plate Safety Device	When any foreign object falls between the pallets and the comb plate, stop the moving walk.	CSS	Ⓢ	Ⓢ
Detection of Contactor Action	In case of any abnormality with the contactor, stop the moving walk.	CTD	Ⓢ	Ⓢ
Drive Chain Safety Device	When the drive chain breaks or extends abnormally, stop the moving walk.	DCS	Ⓢ	Ⓢ
Cover Plate Safety Device	When the maintenance cover plate is taken out, stop the moving walk or prevent it from starting.	DOS	Ⓢ	Ⓢ
Emergency Stop Button	In emergency, use this device to stop the moving walk.	E-STOP	Ⓢ	Ⓢ
Detection of Auxiliary Brake Actions	When the auxiliary brake is not in place, prevent the moving walk from starting. (When the rise is above 6m)	EBR *3	Ⓢ	Ⓢ
Electric Safety Circuit Protection	When there is any action in the electric safety devices connected in serial, stop the moving walk.	ESC	Ⓢ	Ⓢ
Detection of Braking Distance	When the brake distance gets longer than 1.2 times the defined maximum, prevent the moving walk from starting.	ESD	Ⓢ	Ⓢ
Handrail Anti-static Device	The device prevents static from occurring on the handrail.	HER	Ⓢ	Ⓢ
Over-speed	Stop the moving walk before the operational velocity grows above 1.2 times the nominal velocity.	HGD1	Ⓢ	Ⓢ
Over-speed Limitation Device	Stop the moving walk before the operational velocity grows above 1.4 times the nominal velocity. (when the rise is above 6m)	HGD2 *3	Ⓢ	Ⓢ
Handrail Inlet Safety Device	When any foreign object gets pinched into the handrail inlet, stop the moving walk.	HGS	Ⓢ	Ⓢ
Handrail Velocity Inspection	When the velocity of the handrail is below the rated value, and the condition lasts for a period of time, stop the moving walk.	HSS	Ⓢ	Ⓢ
Under-voltage Protection	When the voltage of the frequency converter is too low, stop the moving walk.	LVP	—	Ⓢ
Over-current Protection	When the electric current of the frequency converter is too strong, stop the moving walk.	OCP	—	Ⓢ
Motor Overload Protection	When the motor is overloaded, stop the moving walk.	OCR	Ⓢ	Ⓢ
Over-voltage Protection	When the voltage of the frequency converter is too high, stop the moving walk.	OVP	—	Ⓢ
Pallet chain safety device	If the pallet chain is broken or abnormally extended, this device will cut off the power supply of the drive motor and the brake.	PCS	Ⓢ	Ⓢ
Pallet Anti-static Device	The device prevents static from occurring on the pallet.	PER	Ⓢ	Ⓢ
Detection of Power Phase	Automatically inspect the power phase and frequency, and switch to bypass frequency converter in a shock-free manner. Realize self-adaptation control of power factors with the full frequency converter.	PLL	—	Ⓢ
Pallet Missing Safety Device	When there is any pallet missing, the device takes action to stop the moving walk.	PMS	Ⓢ	Ⓢ
Pallet Sinking Safety Device	If the pallet sinks and the step cannot mesh with the comb plate, stop the moving walk.	PRS	Ⓢ	Ⓢ
Error of the Passenger Detection Device	Self-diagnosis of error with the passenger detection device. In case of any error, cancel the standby model.	PSD	—	Ⓢ
Skirting Panel Safety Device	When any foreign object falls between steps and skirting panels, stop the moving walk.	SSS	Ⓢ	Ⓢ
Monitoring Cohesion of the Starting Switch	In case of cohesion of the starting switch, prevent the moving walk from starting.	SWD	Ⓢ	Ⓢ
Overheating Protection of Frequency Converter	When the frequency converter is overheated, stop the moving walk.	THMF	—	Ⓢ
Low Velocity Protection	When the velocity of the escalator is below the rated velocity, stop the moving walk.	USP	Ⓢ	Ⓢ
■ Emergency Operations				
Fire Stop	When a signal of fire-fighting action is received, stop the moving walk.	FSS	Ⓞ	Ⓞ
■ Operations and Service Functions				
Repair	The escalator can be set to the operation under repair model, to make the installation and commissioning convenient.	HAND	Ⓢ	Ⓢ
Manually Shut Down Illumination	Open or shut down illumination manually with the switch. (When auxiliary illumination below steps and/or at the handrails is equipped)	LO-M *4	Ⓢ	Ⓢ
Automatic Operation	Through the usage of passenger detection devices, the moving walk could operate with the nominal speed when there is any passenger, and shift to standby in case of no load.	MDA	—	Ⓢ
Operation with Constant Velocity	The moving walk keeps at the nominal velocity.	MDC	Ⓢ	—
Automatic Oil Feeding	Add lubricating oil to the chains of the moving walk at predetermined time automatically.	OIL	Ⓢ	Ⓢ
Passenger Detection Device: Microwave but not the Column Pattern	Adopt microwave sensors for the passenger detection device.	PSM *5	—	Ⓞ

Feature	Description	Code	Non-frequency Conversion	Frequency Conversion
■ Operations and Service Functions				
Passenger sensing device: photoelectric non-pillar type	Only for variable-frequency moving walk; passenger sensing device: select one from three.	PSO *5*6	—	Ⓞ
Passenger Detection Device: Column Pattern	Adopt the photoelectric column for the passenger detection device.	PSP *5*6	—	Ⓞ
Low Velocity Standby	The moving walk operates below the nominal velocity in the condition of no load.	SBLS *7	—	Ⓞ
Stop Standby	The moving walk stops in the condition of no load.	SBSP *7	—	Ⓞ
Direct Start-up	Supply power with direct drive with mains at both starting and operation of the moving walk, and the frequency converter serves merely as a backup.	SDT *8	Ⓢ	Ⓢ
Optional Directions of Operation	The direction of moving walk operation could be reversed.	UDA	Ⓢ	Ⓢ
Bypass Frequency Converter	Supply power with frequency converter at starting, stop, and low velocity standby, and shift to direct drive with mains during operations with rated velocity.	VFBF	—	Ⓢ
■ Information and Display				
Displaying Safety Device Codes	Carry out one-on-one inspection on safety devices, and display response error codes if there is any error.	ASD *6	Ⓞ	Ⓞ
BA Interface	Use passive dry contact to output signals indicating basic status of the moving walk.	BA	Ⓞ	Ⓞ
Buzzer	Remind the passengers of moving walk starting, error, reversion, and etc.	BUZ	Ⓢ	Ⓢ
Operational Direction Indication	Indicate the passengers the operational direction, stop, no entry, or other conditions of the moving walk.	DI	Ⓞ	Ⓢ
Reminder of Fire-protection Stop	When the moving walk stops for fire-protection reasons, release the signal of fire-protection stop.	FE-CP	Ⓞ	Ⓞ
Handrail Illumination	Illumination at the lower edge of the handrail.	L-BAL *9	Ⓢ	Ⓢ
The Monitoring System	The system monitors the status of the moving walk with computers, and gives orders of starting or stop when necessary.	SMOS-II	Ⓞ	Ⓞ

Note:

- *1 Standard component when the rise is above 6 meters.
- *2 Non-standard component when the rise is 6 meters or below.
- *3 Standard component when auxiliary brakes are equipped.
- *4 When there is illumination system on the escalator.
- *5 PSM, PSO or PSP (PSM is the recommended option)
- *6 Non-standard
- *7 SBLS or SBSP (SBSP is recommended indoor option)
- *8 The normal start-up model for non-frequency conversion escalators, and backup for frequency conversion escalators.
- *9 Only for indoor CS-LB/CS-L BF
- *10 Ⓢ Standard functions, Ⓞ optional functions

Building Project Layout for Moving Walk of Horizontal Type

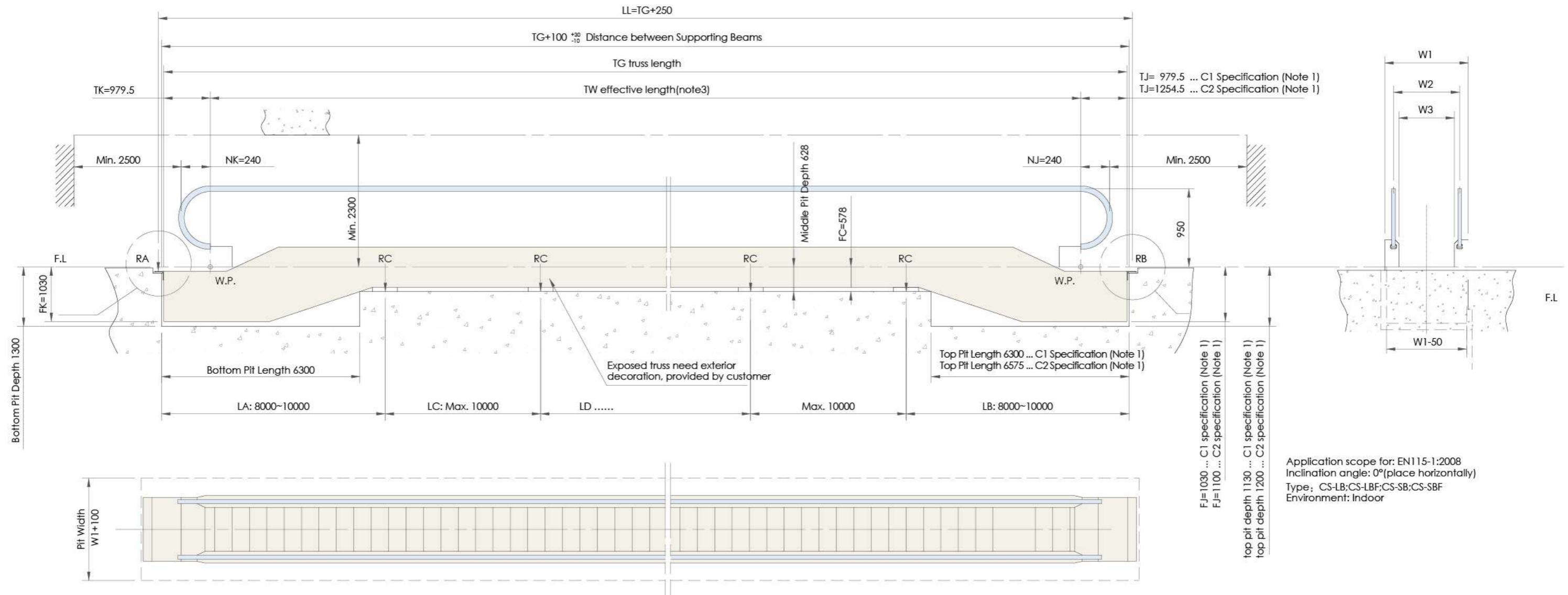

Civil Work Data

Item	Specification	Note
Length of the Upper Truss(mm)	979.5	Motor Power Capacity<11
	1254.5	Motor Power Capacity=11
Length of the Lower Truss(mm)	979.5	
Top Pit Depth(mm)	1030	Motor Power Capacity<11
	1100	Motor Power Capacity=11
Depth of the Middle Truss(mm)	578	
Bottom Pit Depth(mm)	1030	
Width of the Moving Walk(mm)	1550	Handrail nominal width 1200
	1750	Handrail nominal width 1400
	1950	Handrail nominal width 1600
Number Between Intermediate	1, 2, 3, 4, 5, 6, 7, 8, 9, 10	

Item	Specification	Note
Distance Between Intermediate Supports LA	8000-10000	1, 2, 3, 4, 5, 6, 7, 8, 9, 10 intermediate supports
Distance Between Intermediate Supports LB	8000-10000	1, 2, 3, 4, 5, 6, 7, 8, 9, 10 intermediate supports
Distance Between Intermediate Supports LC	500-10000	2, 3, 4, 5, 6, 7, 8, 9, 10 intermediate supports
Distance Between Intermediate Supports LD	500-10000	3, 4, 5, 6, 7, 8, 9, 10 intermediate supports
Distance Between Intermediate Supports LE	500-10000	4, 5, 6, 7, 8, 9, 10 intermediate supports
Distance Between Intermediate Supports LF	500-10000	5, 6, 7, 8, 9, 10 intermediate supports
Distance Between Intermediate Supports LG	500-10000	6, 7, 8, 9, 10 intermediate supports
Distance Between Intermediate Supports LH	500-10000	7, 8, 9, 10 intermediate supports
Distance Between Intermediate Supports LI	500-10000	8, 9, 10 intermediate supports
Distance Between Intermediate Supports LJ	500-10000	9, 10 intermediate supports
Distance Between Intermediate Supports LK	500-10000	10 intermediate supports

Note 1: For C1, using 5.5, 7.5 kW motor; For C2, using 11kW motor.

Note 2: This drawing is only applicable for indoor moving walk. For circumstances of outdoor, civil construction size and requirement varies greatly, please contact Shanghai Mitsubishi Elevator Co.,Ltd

Note 3: This lay-out is only for schematic description. The detail of request and paramter, please contact with Shanghai Mitsubishi elevator.

Building Project Layout for Moving Walk of Inclination Type

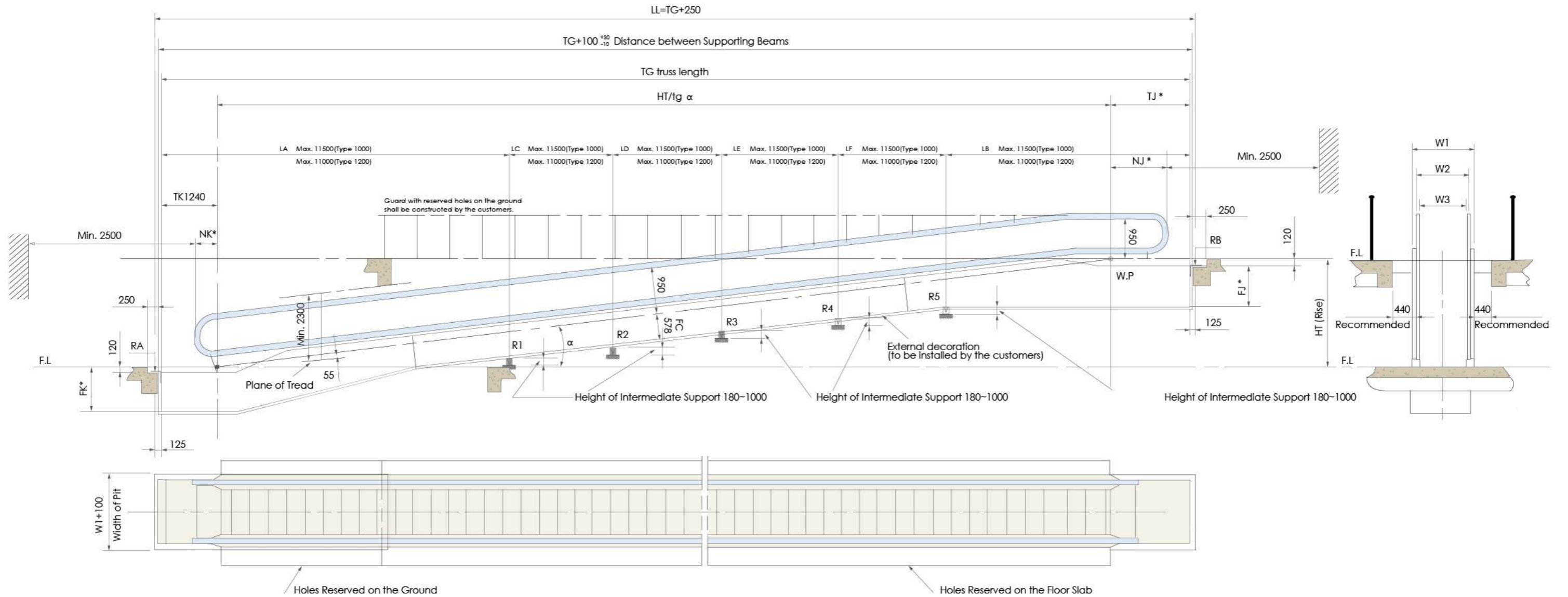

Civil Work Data

Item	Specification	Note
Length of the Upper Truss(mm)	2070	INC=11.31°, Motor Power Capacity≤7.5
	2345	INC=11.31°, Motor Power Capacity=11
	1672	6°<INC≤8°, Motor Power Capacity≤7.5
	1947	6°<INC≤8°, Motor Power Capacity=11
	1917	8°<INC≤10°, Motor Power Capacity≤7.5
	2192	8°<INC≤10°, Motor Power Capacity=11
	2034	10°<INC≤11°, Motor Power Capacity≤7.5
	2309	10°<INC≤11°, Motor Power Capacity=11
	2148	11°<INC≤12°, Motor Power Capacity≤7.5, INC≠11.31
2423	11°<INC≤12°, Motor Power Capacity=11, INC≠11.31	
Length of the Lower Truss(mm)	1240	
Top Pit Depth(mm)	1030	Motor Power Capacity≤7.5
	1100	Motor Power Capacity=11
Depth of the Middle Truss(mm)	1040	
Bottom Pit Depth(mm)	578	

Item	Specification	Note
Width of the Moving Walk(mm)	1350	Handrail nominal width 1000
	1550	Handrail nominal width 1200
Number Between Intermediate	0, 1	Handrail nominal width 1200, TG≤11000; Handrail nominal width 1000, TG≤11500
	1, 2, 3, 4	Handrail nominal width 1200, TG>11000; Handrail nominal width 1000, TG>11500
Distance Between Intermediate Supports LA	6000-11000	Handrail nominal width 1200, 1, 2, 3, 4 intermediate supports
	6000-11500	Handrail nominal width 1000, 1, 2, 3, 4 intermediate supports
Distance Between Intermediate Supports LB	6000-11000	Handrail nominal width 1200, 1, 2, 3, 4 intermediate supports
	6000-11500	Handrail nominal width 1000, 1, 2, 3, 4 intermediate supports
Distance Between Intermediate Supports LC	500-11000	Handrail nominal width 1200, 2, 3, 4 intermediate supports
	500-11500	Handrail nominal width 1000, 2, 3, 4 intermediate supports
Distance Between Intermediate Supports LD	500-11000	Handrail nominal width 1200, 3, 4 intermediate supports
	500-11500	Handrail nominal width 1000, 3, 4 intermediate supports
Distance Between Intermediate Supports LE	500-11000	Handrail nominal width 1200, 4 intermediate supports
	500-11500	Handrail nominal width 1000, 4 intermediate supports

Note: When The size TG for model 1200 is more than 11000mm, the intermediate supports are needed.

Relation between the Driving Power and the Nominal Length(TW) for Moving walk of Horizontal Type

Item	Specification														Power(kW)
Handrail Nominal Width(mm)	1200							1400/1600							
Operation Speed(m/s)	0.5							0.5							
Inclination Angle	0°	1°	2°	3°	4°	5°	6°	0°	1°	2°	3°	4°	5°	6°	
Effective Length(m)	70	50	40	35	30	25	20	60	45	35	25	25	20	15	5.5 (C1)
	95	70	60	50	40	35	30	80	60	50	40	35	30	25	7.5 (C1)
	100	95	90	75	60	55	50	100	90	70	60	50	45	40	11 (C2)
Operation Speed(m/s)	0.65							0.65							
Inclination Angle	0°	1°	2°	3°	4°	5°	6°	0°	1°	2°	3°	4°	5°	6°	
Effective Length(m)	50	40	30	25	20	20	15	45	30	25	20	15	15	15	5.5 (C1)
	70	55	45	35	30	25	25	60	45	35	30	25	20	20	7.5 (C1)
	100	85	65	55	45	40	35	95	75	55	45	40	35	25	11 (C2)

Relation between the Driving Power and the Max.Height of Travel for Moving Walk of Inclination Type

Item	Specification							
Serial No.	CS-LB CS-LBF	CS-LB CS-LBF	CS-LB CS-LBF	CS-LB CS-LBF	CS-SB CS-SBF	CS-SB CS-SBF	CS-SB CS-SBF	CS-SB CS-SBF
Handrail Nominal Width(mm)	1000	1200	1000	1200	1000	1200	1000	1200
Operation Speed(m/s)	0.5		0.65		0.5		0.5	
Power/Inclination Angle 8°								
5.5KW(C1)	4m	3.4m	3.1m	2.6m	3.2m	2.8m	3.0m	2.4m
7.5KW(C1)	6m	4.7m	4.3m	3.6m	5.2m	4.4m	4.4m	3.2m
11KW(C2)	6.7m	6.7m	6.4m	5.4m	—	5.2m	5.2m	5.0m
Power/Inclination Angle 10°								
5.5KW(C1)	4.4m	3.7m	3.3m	2.8m	3.5m	3m	3.2m	2.5m
7.5KW(C1)	6m	5.1m	4.6m	3.9m	5.9m	4.6m	4.7m	3.7m
11KW(C2)	7.7m	7.6m	6.9m	5.8m	—	5.9m	5.9m	5.3m
Power/Inclination Angle 11°								
5.5KW(C1)	4.5m	3.8m	3.4m	2.9m	3.6m	3.1m	3.3m	2.6m
7.5KW(C1)	6m	5.2m	4.8m	4m	6.0m	4.7m	4.8m	3.8m
11KW(C2)	8.2m	7.8m	7.1m	6m	6.2m	6.2m	6.2m	5.4m
Power/Inclination Angle 11.31°								
5.5KW(C1)	4.5m	3.8m	3.4m	2.9m	3.7m	3.1m	3.3m	2.6m
7.5KW(C1)	6m	5.2m	4.8m	4m	6.0m	4.7m	4.8m	3.8m
11KW(C2)	8.4m	7.8m	7.2m	6m	6.3m	6.3m	6.3m	5.4m
Power/Inclination Angle 12°								
5.5KW(C1)	4.6m	3.8m	3.5m	2.9m	3.8m	3.2m	3.4m	2.7m
7.5KW(C1)	6m	5.3m	4.9m	4.1m	6.0m	4.8m	4.9m	3.9m
11KW(C2)	8.6m	7.9m	7.3m	6m	6.5m	6.5m	6.5m	5.5m

Requirements for Choosing and Applying Shopping Carts and Luggage Carts on Moving Walk

- It's permitted to applying carts with eligible design on moving walk (according to EN 1929-2 and 1929-4). The manufacturers of shopping carts and luggage carts must certify that the carts are coordinate with moving walk. Otherwise, there might be a danger. It's necessary to prevent incoordinate carts getting on moving walk.
- The width of carts and the goods they are carrying must be 400mm less than width of step treads so that passengers can leave even if the carts are on moving walk.
- The rated speed must be limited to 0.5 m/s for moving walks with an inclination angle greater than 6°
- The diameter of roller wheel on carts must be 120 mm at least.
- Shopping carts and luggage carts must be in accordance with the design of moving walk:
 - Ensure the design of shopping carts and luggage carts is safe for correct carrying.
 - When shopping carts and luggage carts are in full load, the maximum weight of them is 75kg.
 - Shopping carts and luggage carts must be configured with self-hold device when they are on inclination part of moving walk.
 - Stop device must be configured.
 - Anti-divergence device (buffer) must be configured for avoiding danger of being jammed.
 - When getting off moving walk, it's necessary for rear wheel of carts pushing fore wheel to roll across the comb, and fore wheel and stop device must be easily released from steps.
 - To ensure the alignment after shopping carts and luggage carts getting on moving walk, anti-divergence device and guide device must spread to surrounding area.
 - Add safe signs for safe and correct usage of shopping carts and luggage carts.

Before applying the carts formally, do tests to confirm there is no problem.

The size reference of roller wheels on carts is shown in the figure below:

Sectional View of Step Treads on Moving Walk

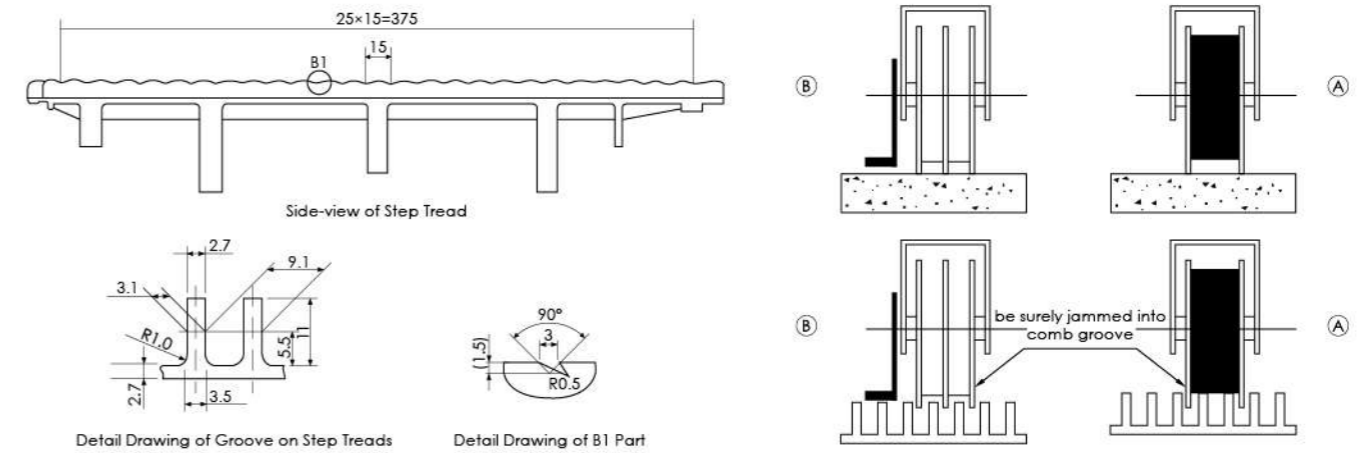

Basic Specifications for Moving Walk of Horizontal Type

Item	Specification			Note
Nominal Width Between Handrails (mm)	1200	1400	1600	For type CS-B, CS-LB, CS-BF, CS-LBF
Distance Between Center Lines of Handrails (mm)	1280	1480	1680	For type CS-SB, CS-SBF
	1208	1408	1608	
Nominal Width of Pallet (mm)	1004	1204	1404	
Maximum Load (Person/Hour)	6000	6000	6000	Velocity: 0.5m/s
	7300	7300	7300	Velocity: 0.65m/s
Effective Length(m)	12-100	12-100	12-100	INC=0°, Velocity: 0.5m/s
	12-100	12-95	12-95	INC=0°, Velocity: 0.65m/s
	12-95	12-90	12-90	0°<INC<1°, Velocity: 0.5m/s
	12-85	12-70	12-70	0°<INC<1°, Velocity: 0.65m/s
	12-90	12-70	12-70	1°<INC<2°, Velocity: 0.5m/s
	12-65	12-55	12-55	1°<INC<2°, Velocity: 0.65m/s
	12-75	12-60	12-60	2°<INC<3°, Velocity: 0.5m/s
	12-55	12-45	12-45	2°<INC<3°, Velocity: 0.65m/s
	12-60	12-50	12-50	3°<INC<4°, Velocity: 0.5m/s
	12-45	12-40	12-40	3°<INC<4°, Velocity: 0.65m/s
	12-55	12-45	12-45	4°<INC<5°, Velocity: 0.5m/s
	12-40	12-35	12-35	4°<INC<5°, Velocity: 0.65m/s
	12-50	12-40	12-40	5°<INC<6°, Velocity: 0.5m/s
	12-35	12-30	12-30	5°<INC<6°, Velocity: 0.65m/s
Serial No.	CS-B, CS-LB, CS-SB, CS-BF, CS-LBF, CS-SBF			
Angle of Inclination (Degree)	0-6			
Velocity (m/s)	0.5, 0.65			
Applicable Environment	Indoor			
Drive System	Direct Drive			For type CS-B, CS-LB, CS-SB
	VVVF Drive			For type CS-BF, CS-LBF, CS-SBF
Drive Power Supply	380V50Hz three-phase and five-wire			
Illumination Power Supply	220V50Hz single phase			

Illumination Power (single phase AC 220V, 50Hz)

Serial No.	CS-LB,CS-LBF	CS-B,CS-BF,CS-SB,CS-SBF	
Illumination Power Capacity (kVA)	2.3	1.3	12<Effective Length<20
	3.5	1.3	20<Effective Length<40
	4.5	1.3	40<Effective Length<60
	5.5	1.3	60<Effective Length<80
	6.7	1.3	80<Effective Length<100

Driving Power (three phase AC 380V, 50Hz)

Driving Power Capacity (kVA)		Motor Power Capacity
8		Motor Power Capacity=5.5
10.4		Motor Power Capacity=7.5
15.4		Motor Power Capacity=11

Basic Specifications for Moving Walk of Inclination Type

Item	Specification		Note
Nominal Width Between Handrails (mm)	1000	1200	For type CS-LB, CS-LBF, CS-B, CS-BF
Distance Between Center Lines of Handrails (mm)	1080	1280	For type CS-SB, CS-SBF
	1008	1208	
Nominal Width of Pallet (mm)	804	1004	
Maximum Load (Person/Hour)	4800	6000	Velocity: 0.5m/s
	5900	7300	Velocity: 0.65m/s
Rise(mm)	2023-5400	2023-5400	6°<INC≤8°, Velocity: 0.5m/s, For type CS-LB, CS-LBF, CS-B, CS-BF
	2023-5200	2023-5200	6°<INC≤8°, Velocity: 0.65m/s, For type CS-LB, CS-LBF, CS-B, CS-BF
	2023-4300	2023-4300	6°<INC≤8°, Velocity: 0.5m/s, For type CS-SB, CS-SBF
	2023-4300	2023-4300	6°<INC≤8°, Velocity: 0.65m/s, For type CS-SB, CS-SBF
	2023-6700	2023-6700	8°<INC≤10°, Velocity: 0.5m/s, For type CS-LB, CS-LBF, CS-B, CS-BF
	2023-6400	2023-5400	8°<INC≤10°, Velocity: 0.65m/s, For type CS-LB, CS-LBF, CS-B, CS-BF
	2023-5200	2023-5200	8°<INC≤10°, Velocity: 0.5m/s, For type CS-SB, CS-SBF
	2023-5200	2023-5000	8°<INC≤10°, Velocity: 0.65m/s, For type CS-SB, CS-SBF
	2023-7700	2023-7600	10°<INC≤11°, Velocity: 0.5m/s, For type CS-LB, CS-LBF, CS-B, CS-BF
	2023-6900	2023-5800	10°<INC≤11°, Velocity: 0.65m/s, For type CS-LB, CS-LBF, CS-B, CS-BF
	2023-5900	2023-5900	10°<INC≤11°, Velocity: 0.5m/s, For type CS-SB, CS-SBF
	2023-5900	2023-5300	10°<INC≤11°, Velocity: 0.65m/s, For type CS-SB, CS-SBF
	2145-8200	2145-7800	11°<INC≤12°, INC≠11.31°, Velocity: 0.5m/s, For type CS-LB, CS-LBF, CS-B, CS-BF
	2145-7100	2145-6000	11°<INC≤12°, INC≠11.31°, Velocity: 0.65m/s, For type CS-LB, CS-LBF, CS-B, CS-BF
	2145-6200	2145-6200	11°<INC≤12°, INC≠11.31°, Velocity: 0.5m/s, For type CS-SB, CS-SBF
	2145-6200	2145-5400	11°<INC≤12°, INC≠11.31°, Velocity: 0.65m/s, For type CS-SB, CS-SBF
	2023-8400	2023-7800	INC: 11.31°, Velocity: 0.5m/s, For type CS-LB, CS-LBF, CS-B, CS-BF
	2023-7200	2023-6000	INC: 11.31°, Velocity: 0.65m/s, For type CS-LB, CS-LBF, CS-B, CS-BF
	2023-6300	2023-6300	INC: 11.31°, Velocity: 0.5m/s, For type CS-SB, CS-SBF
	2023-6300	2023-5400	INC: 11.31°, Velocity: 0.65m/s, For type CS-SB, CS-SBF
Serial No.	CS-LB, CS-SB,CS-B, CS-LBF, CS-SBF, CS-BF		
Angle of Inclination (Degree)	8, 10, 11, 11.31, 12		6°<INC<12°
Velocity (m/s)	0.5, 0.65		
	0.5		
Applicable Environment	Indoor		
Drive System	Direct Drive		For type CS-B, CS-LB, CS-SB
	VVVF Drive		For type CS-BF, CS-LBF, CS-SBF
Drive Power Supply	380V50Hz three-phase and five-wire		
Illumination Power Supply	220V50Hz single phase		

Illumination Power (single phase AC 220V, 50Hz)

Serial No.	CS-LB,CS-LBF	CS-B,CS-BF,CS-SB,CS-SBF	
Illumination Power Capacity (kVA)	2.6	1.3	Rise ≤3000
	3.7	1.3	3000<Rise ≤6000
	4.3	1.3	6000<Rise ≤9000

Driving Power (three phase AC 380V, 50Hz)

Driving Power Capacity (kVA)		Motor Power Capacity
8		Motor Power Capacity=5.5
10.4		Motor Power Capacity=7.5
15.4		Motor Power Capacity=11



**Sense of Secure and Peace
to Create Harmonious Space of Life**

Technology Improves Life

Science Guides the Smart Future

Shanghai Mitsubishi Elevator stays beside you

