



*Changes for the Better*

MOVING WALKS

for a greener tomorrow



Models 1600, 1200

# MOVING WALKS

2nd Edition



# Smooth-Moving Walks for Modern Pedestrian-Traffic Requirements



Mitsubishi Electric Moving Walks are designed to carry people safely, swiftly, and comfortably. The heart of these walks is a highly acclaimed drive system that realizes the maximum in safety and comfort. Moving walks are being increasingly used not only at train stations and airports but also at tourist attractions and in major shopping malls. In addition, they offer a contemporary solution to growing pedestrian traffic requirements resulting from the greater diversity of architectural designs and the expanded scale of urban development. Moving walks can even help to stimulate new architectural ideas. With a complete line-up that includes Models 1200, and the extra-wide 1600, Mitsubishi Electric has the best answer to your pedestrian-traffic requirements.



## Extra Width Boosts Transport Capacity

Mitsubishi Electric Moving Walk, the Model 1600 is wide enough for two people to ride side-by-side without feeling crowded. This roomy design is well suited to contemporary transportation needs—from airport passengers carrying large amounts of luggage to the heavy passenger flow at major train stations. The Model 1600 markedly enhances the efficiency of short-distance pedestrian-traffic systems.

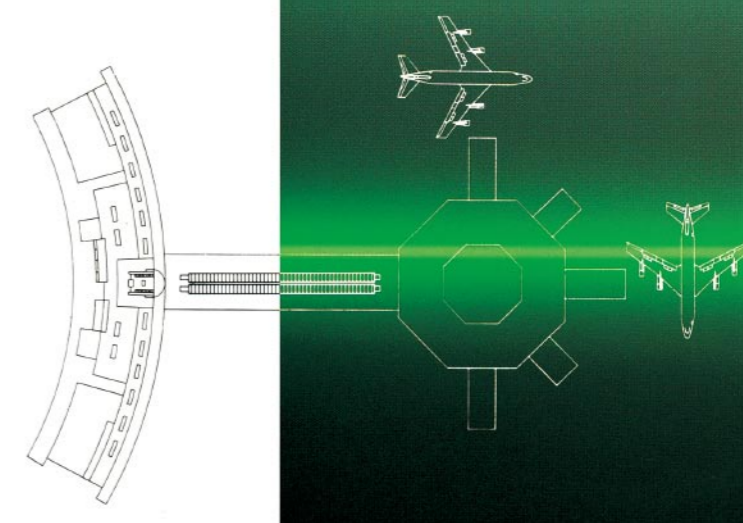
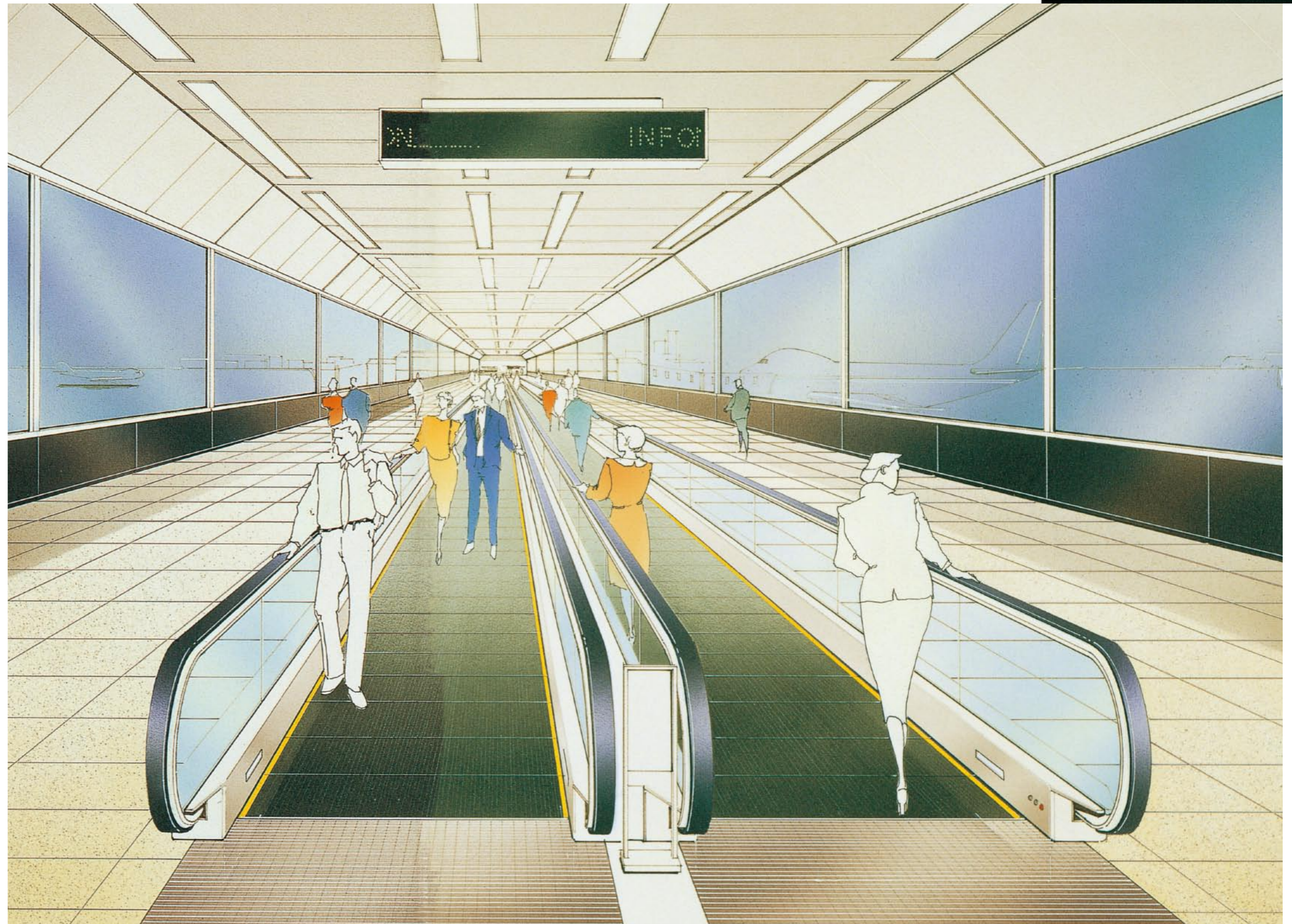



**NEW URBAN DEVELOPMENT**  
**MODEL 1600 HORIZONTAL**

*Greater Freedom of  
Movement in Urban Centers*

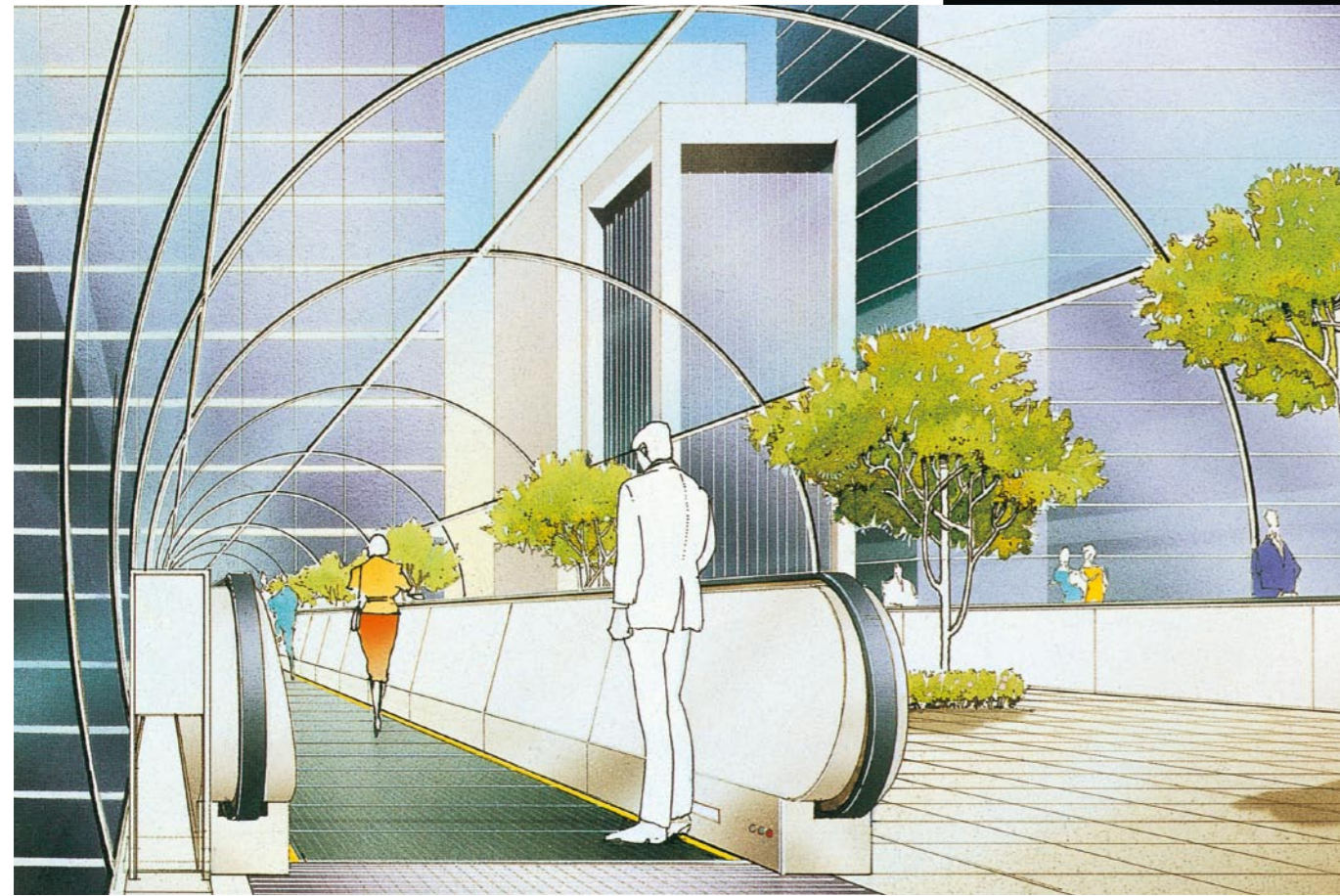
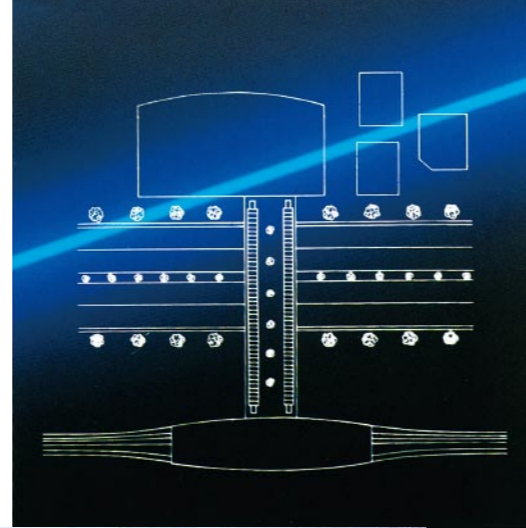

Mitsubishi Electric Moving Walks are designed to link major train stations with urban centers and provide pedestrians with greater freedom of movement while enhancing their comfort. The Model 1600, with its extra-wide walk, is ideally suited to fulfill this role. In fact, the Model 1600 can be used to serve a broad range of social needs.

Because it is wide enough to accommodate a wheelchair with plenty of space for a person to stand alongside, it can provide valuable assistance for the increasing number of handicapped people playing more active roles in society.

**UNDERGROUND SHOPPING AREAS**  
**MODEL 1200 HORIZONTAL**

*An Important Means of  
Transport in  
Underground Facilities*

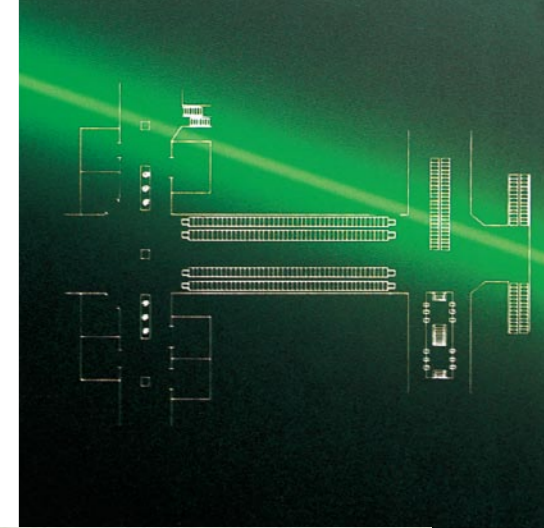

Mitsubishi Electric Moving Walk, the Model 1200 offers ample capacity to handle the heavy flow of pedestrian traffic in the underground passageways that link subways to underground shopping malls and connect major stores. What's more, this smooth riding moving walk provides a respite from the hustle and bustle of the city and a relaxing pause for harried shoppers.





SHOPPING MALLS  
MODEL 1200 INCLINED

*Convenient Transport Between Floors with  
Panoramic Views of the Entire Mall*

Mitsubishi Electric Moving Walk, the Model 1200 Inclined makes shopping a pleasure, and it permits shoppers to move easily between floors with shopping carts or a large number of bags while offering panoramic views of the entire mall at the same time.

The Model 1200 Inclined can also be placed near event areas for the entertainment and amusement of shoppers.

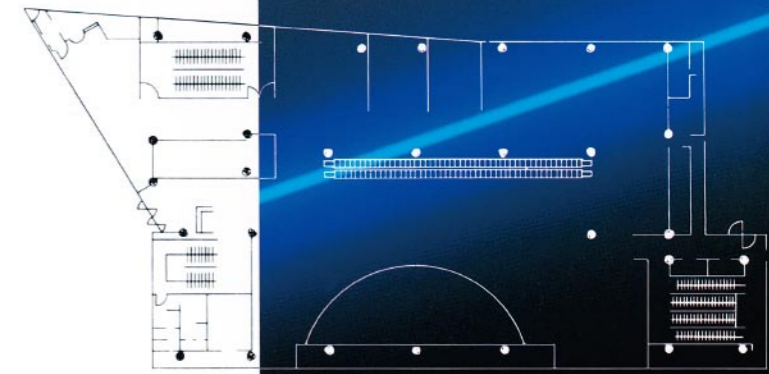
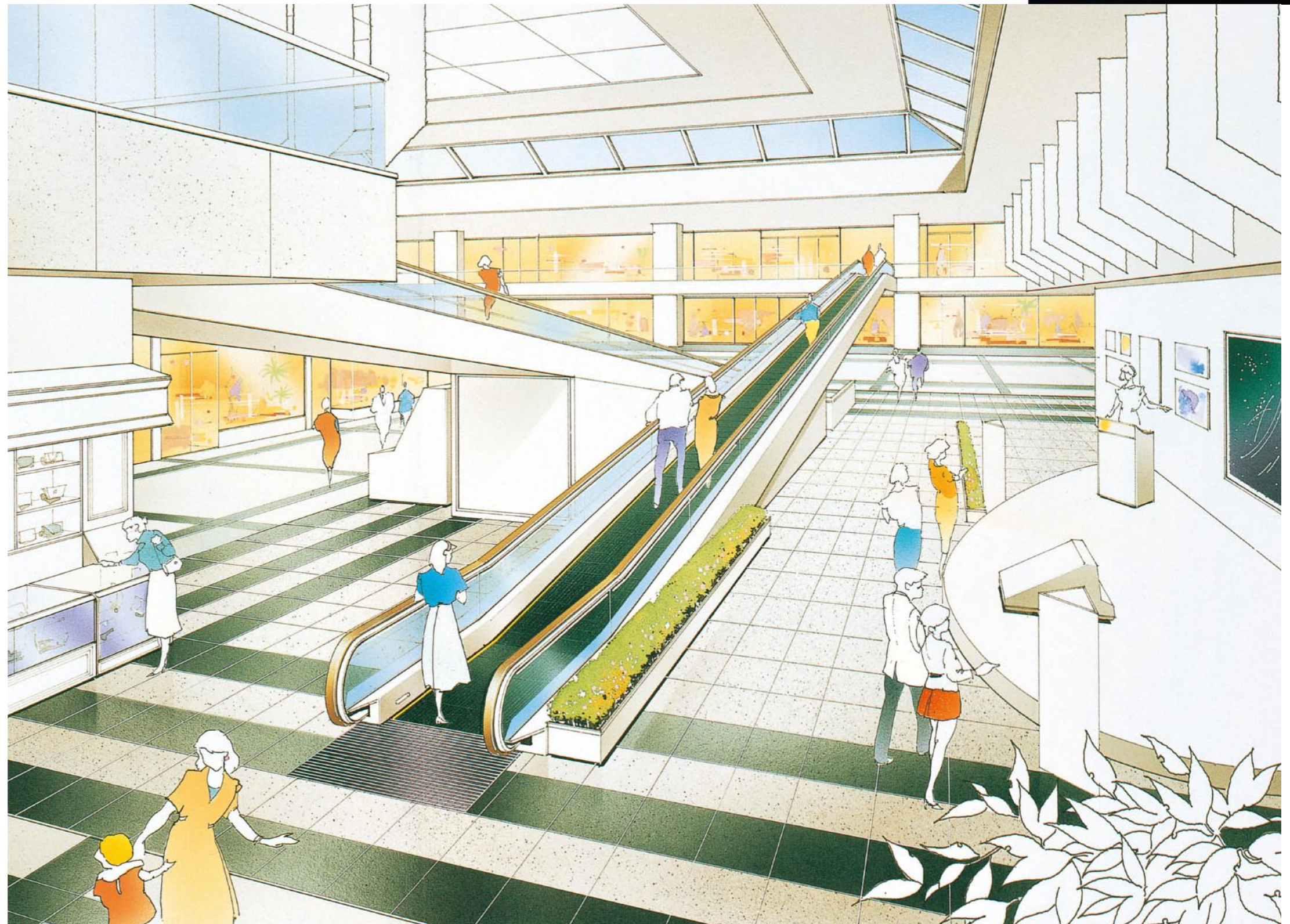



**ELEVATED SITES**  
**MODEL 1200 INCLINED**

*Smooth Riding and Dependable for Easy Customer Access*

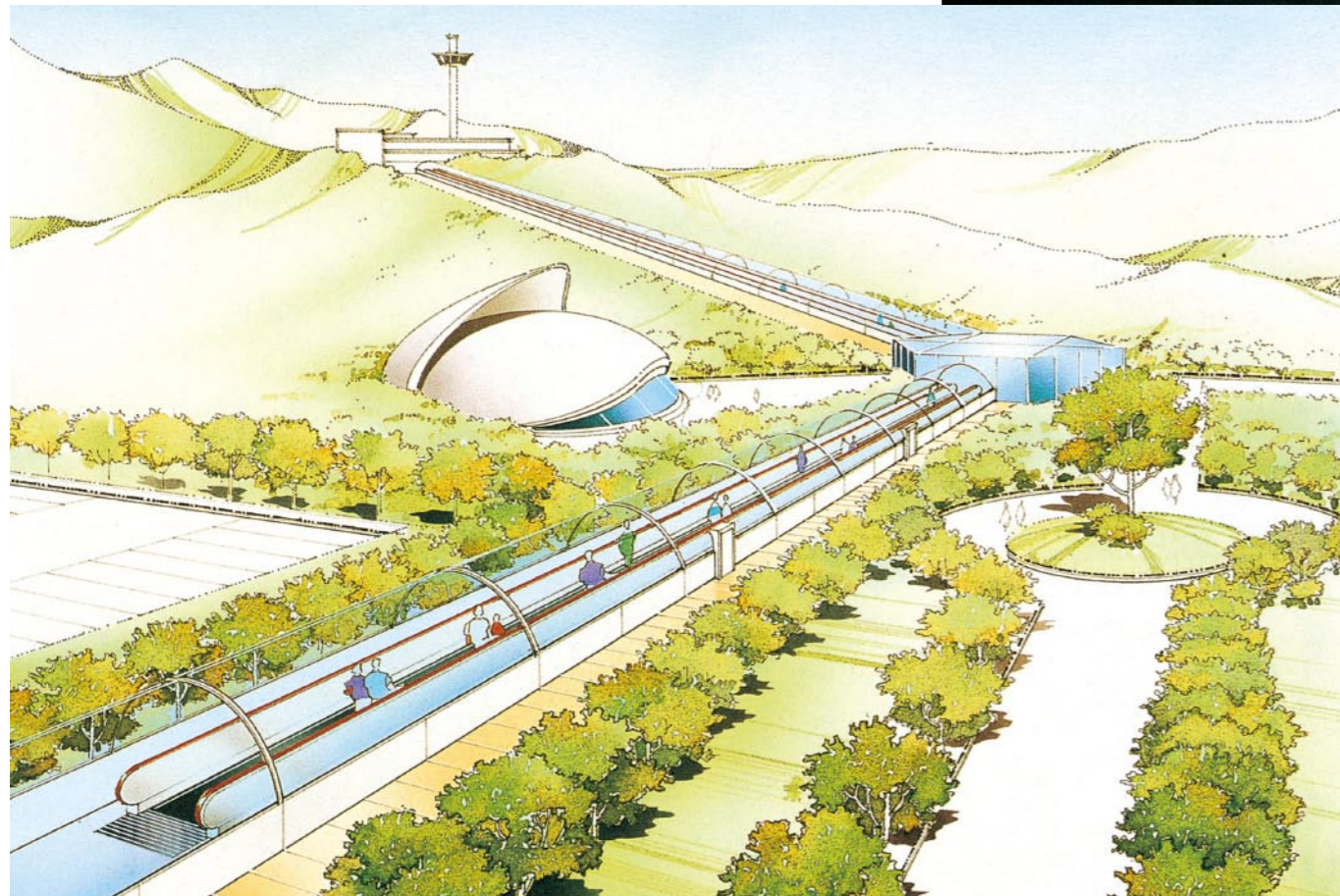
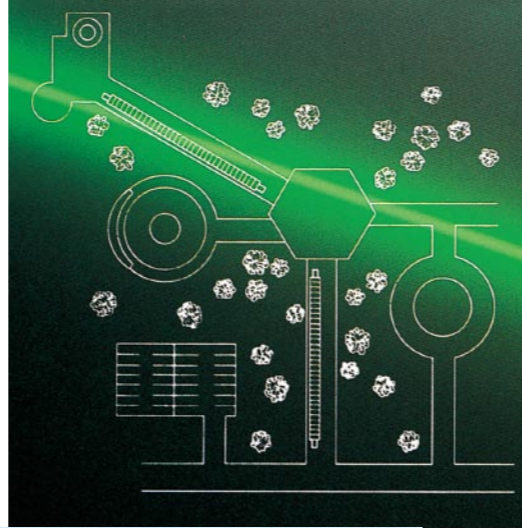

By permitting access by great numbers of people, the Model 1200 Inclined can help to boost attendance at public facilities, tourist attractions, and other places of interest located at elevated sites. The Model 1200 Inclined offers an expansive view of surrounding scenery and provides easy access for elderly persons. In this way, it also enhances the facility's attractions.

**EXPOSITIONS, THEME PARKS**  
**MODEL 1200 MULTIPLE SYSTEM**

*Smooth Pedestrian Flow over Level and Sloping Sites*

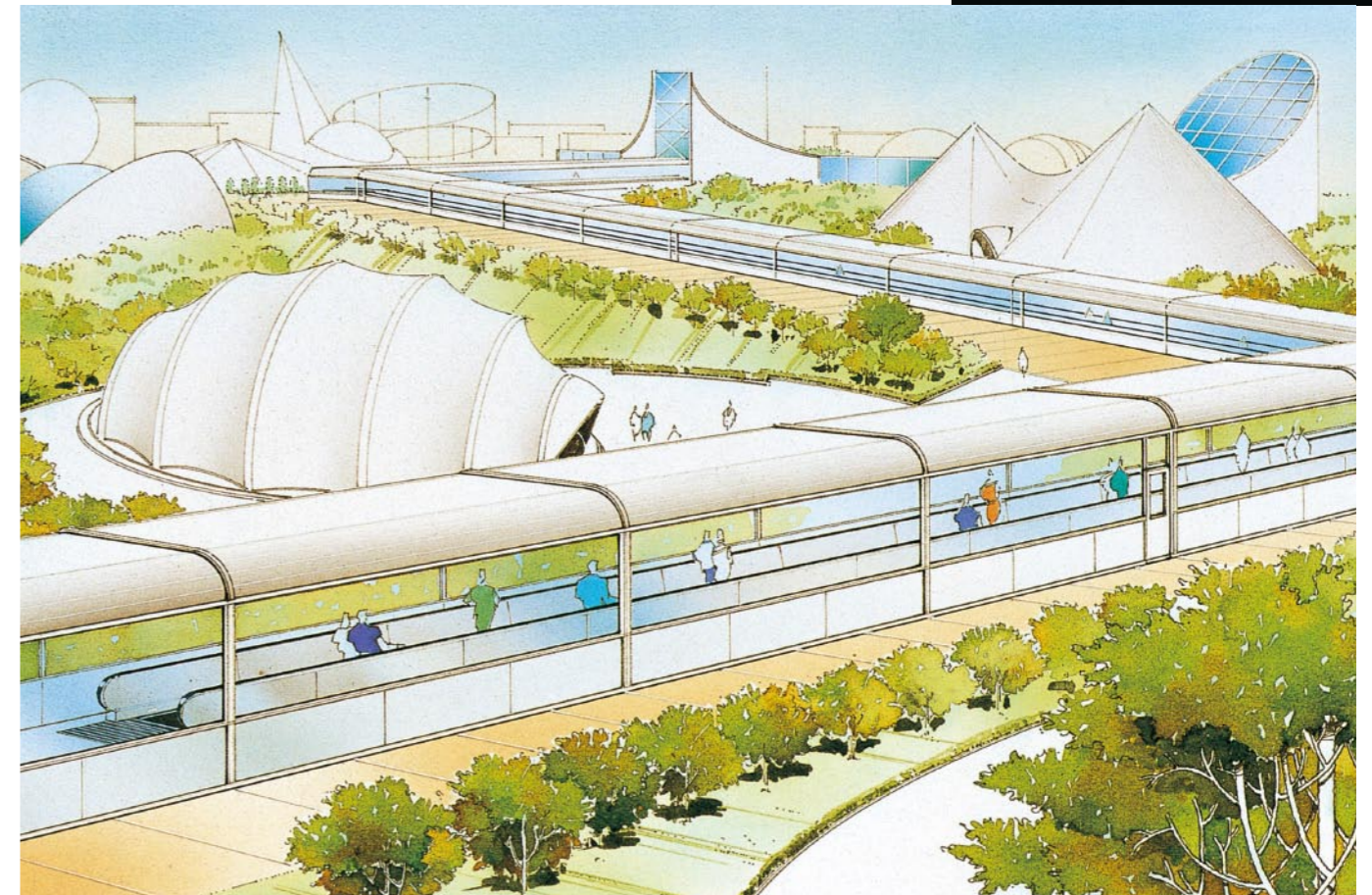
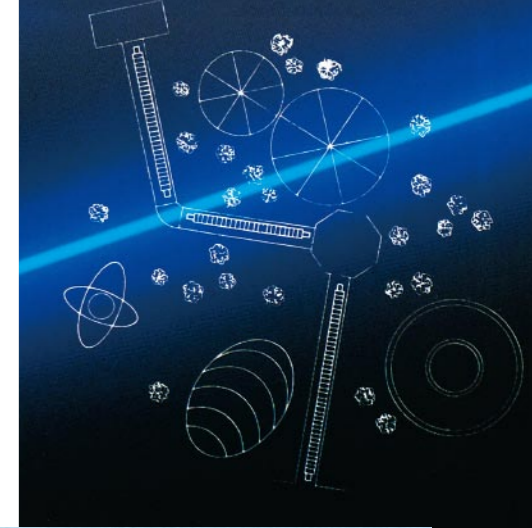

Horizontal and inclined types of Mitsubishi Electric Moving Walks can be used in conjunction to accommodate pedestrian traffic through places with varying elevations.

The multiple system is perfectly suited to easing the heavy pedestrian flow at events such as exhibitions and expositions on gradually sloping hills.

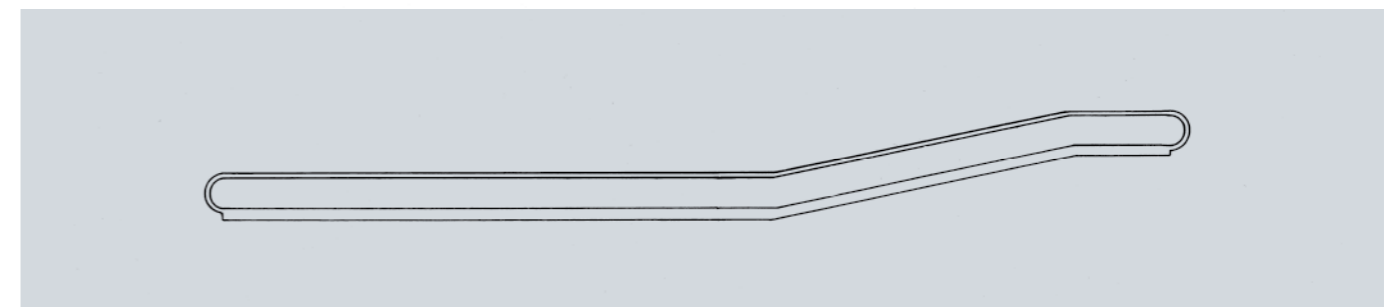



## Features

1

Diecast aluminum alloy is used in the pallets, for comfortable riding and an extended life-span.

2

The treads are designed with the same fine pitch and deep cleats as the steps of our world-renowned escalators, ensuring a precise fit with the landing-comb plates. This makes boarding and alighting easy and safe.

3

Adjacent pallets mesh smoothly to prevent objects from becoming caught and to provide a safe ride even on the pallet joints.

4

The pallets can be made to run in conformity with guiderail configurations, thus allowing overpass and underpass sections that combine the horizontal and inclined types (see page 9).

5

The travel direction can be reversed easily at the operation panel.

6

Shopping carts, baby strollers, and wheelchairs can be used on Mitsubishi Electric Moving Walks. (Extra care should always be taken when using these vehicles on the moving walk.)

7

A drive system with minimal mechanical loss allows power savings of 25% (over our previous models).

8

A space-saving design eliminates waste of valuable space. Reductions in truss width and length result in 8% savings in floor space in Mitsubishi Electric Moving Walk 100m long (as compared with our previous models).

## Enhanced Safety Features

### ● Demarcation Cleats

As with escalator treads, the use of yellow plastic demarcation cleats at both sides of the pallets reminds passengers to maintain a safe distance from the sides.

### ● Narrower Pallet-Cleat Pitch

The pitch of the pallet cleats has been reduced by about 15% and their meshing with the comb has been improved to make it even harder for objects to get caught in the grooves.

### ● Lower Comb-Plate Angle

Lowering the angle of the comb plate has enhanced safety and minimized the discomfort associated with boarding and alighting from Mitsubishi Electric Moving Walk. This improvement also makes it easy to use the moving walk for shopping carts and wheelchairs.

### ● Inlet Guards

These flexible rubber guards prevent fingers from being drawn inside by the movement of the handrail. An emergency switch is also provided to stop the moving walk immediately in the rare event that something does get past the guards.

## Space-Saving Design Allows Significant Reductions in Installation Space

The innovative drive mechanism of Mitsubishi Electric Moving Walks makes possible considerable reductions in the truss width and size. This means savings in floor space of approximately 13m<sup>2</sup> on moving walk 100m long. The longer moving walk, the greater savings in floor space when compared with previous models. Moreover, uniformity in the truss depth throughout the system simplifies architectural planning.

### ● Conventional Model

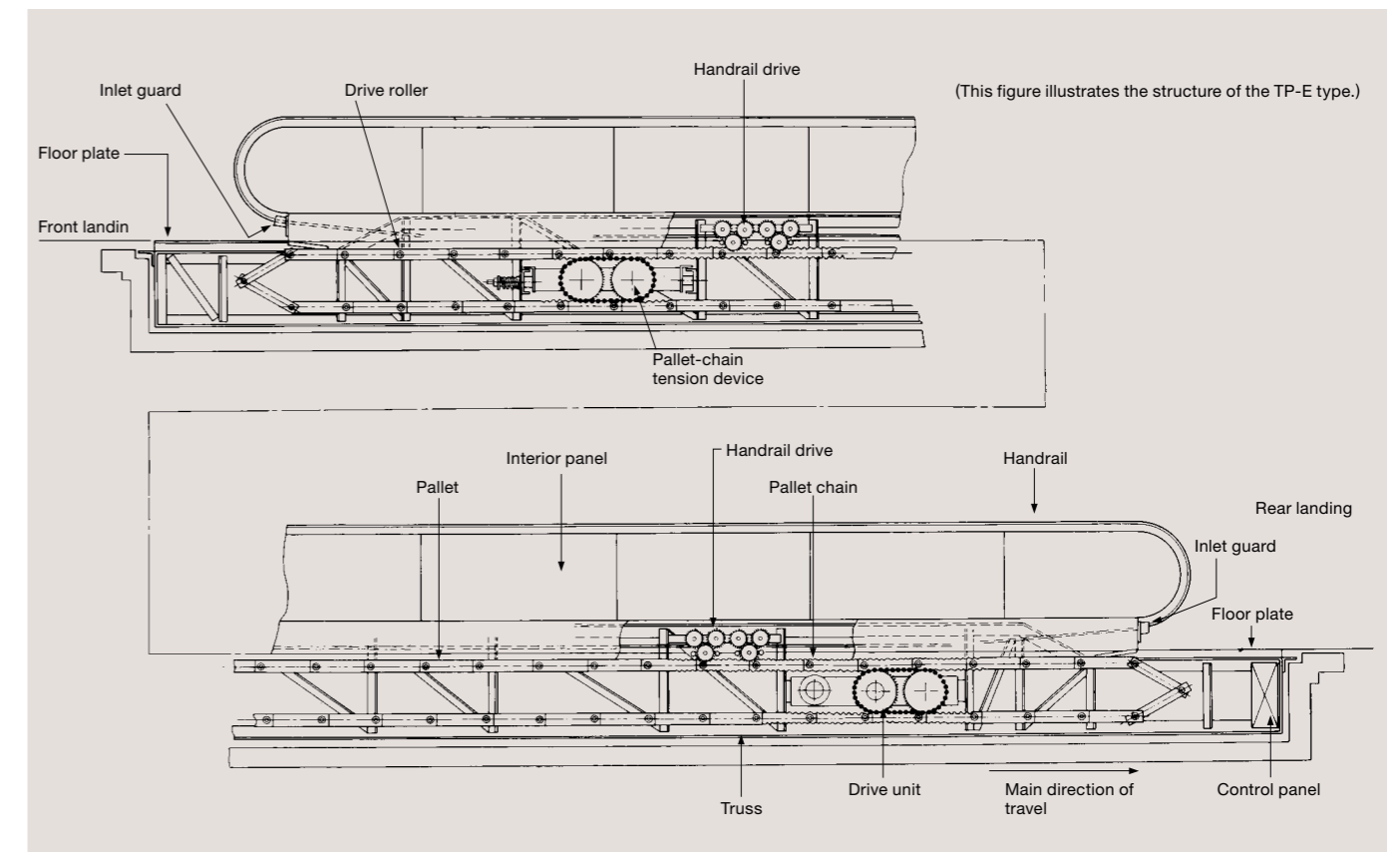
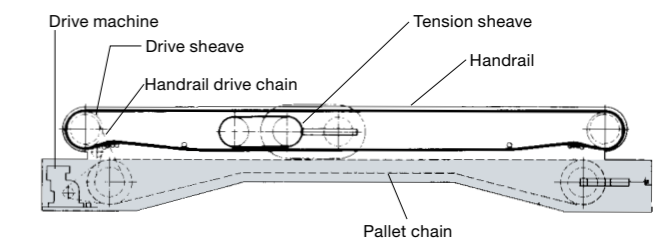

## Options

A full array of options are available to maximize Mitsubishi Electric Moving Walk operating efficiency.

### ● Automatic Operation

Moving walk operates and stops automatically by means of a sensor that detects passengers.

### ● Comb Light at Both Landings

A steady or flashing light is installed at both landings of moving walk to alert passengers.

### ● Automatic Announcement Device

A voice synthesizer is used to announce important information and remind passengers to ride safely.

### ● Horizontal Pallet Grooves

Horizontal grooves in the pallets help prevent passengers from slipping.

# Specifications

Dimensions in this brochure conform to Mitsubishi Electric standard\*. For details of compliance, please consult our local agents.

\*Based on, but not fully complying with the Building Standard Law of Japan, 2009.

## ● Standard Layout of Horizontal TP-E Type

(Please consult our local agents for information on TS-E and TS-LE types.)

Apply to the one which inclination angle is 3-degree or less.

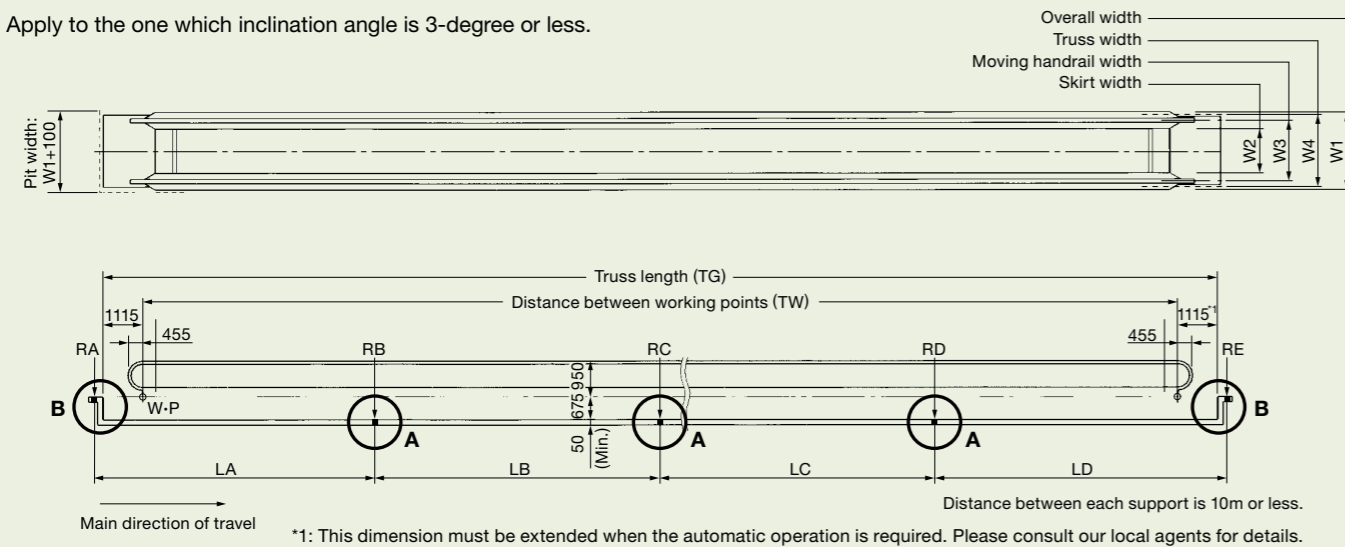

\*1: This dimension must be extended when the automatic operation is required. Please consult our local agents for details.

### ● Motor (kW)

Model	Inclination angle (°)	Speed (m/min)	Distance between working points TW (m)							Remarks
			0	20	30	40	50	60	70	
1200	0	30		20					70	20 ≤ TW ≤ 70 <sup>*2</sup>
		40		20	5.5kW×1				70	
	3	30		20		45	5.5kW×2		70	
		40		20		32			70	
1600	0	30		20					70	20 ≤ TW ≤ 55 <sup>*2</sup>
		40		20	5.5kW×1			55	70	
	3	30		20		35	5.5kW×2		70	
		40		20		25			55	

\*2: Please consult our local agents when the distance between the working points exceeds the maximum value.

### ● Load Factors

Model	$\alpha$ (N/mm)
1200	3.64
1600	4.63

### ● Loads

RA (N)	$\alpha \times LA$
RB (N)	$\alpha \times (LA + LB)$
RC (N)	$\alpha \times (LB + LC)$
RD (N)	$\alpha \times (LC + LD)$
RE (N)	$\alpha \times LD$

(LA, LB, LC, LD: mm)

## ● Standard Specifications

Model	1600	1200
Speed (m/min)	30	40
Carrying capacity (persons/hr)	9000	12000
Inclination angle (°)	0~3	0~3, 12
Power supply	Main	200/400VAC 3-phase, 50 or 60Hz
	Signals	100VAC single-phase, 50 or 60Hz
Operation system	Manual key-switch operation	

## ● Dimensions

(mm)

Model	1600	1200
W1	1946	1550
W2	1406	1010
W3	TP-E	1656
	TS-E	1676
W4	TP-E	1676
	TS-LE	1280
W4	1896	1500

## ● Balustrade Configurations

### ● Type TP-E

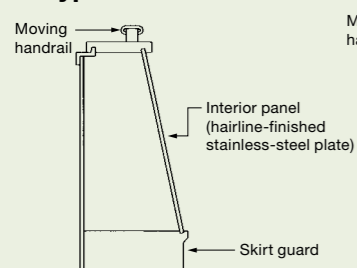

### ● Type TS-E

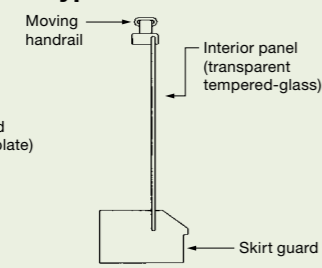

### ● Type TS-LE

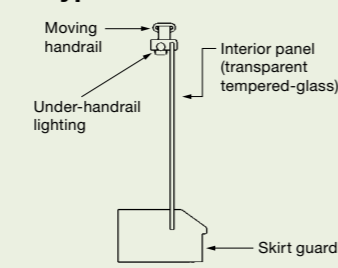

### Detail A

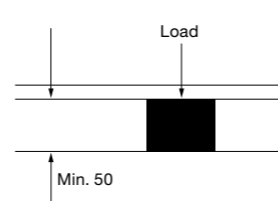

## ● Standard Layout of Inclined TS-E and TS-LE Types

(Please consult our local agents for information on TP-E type.)

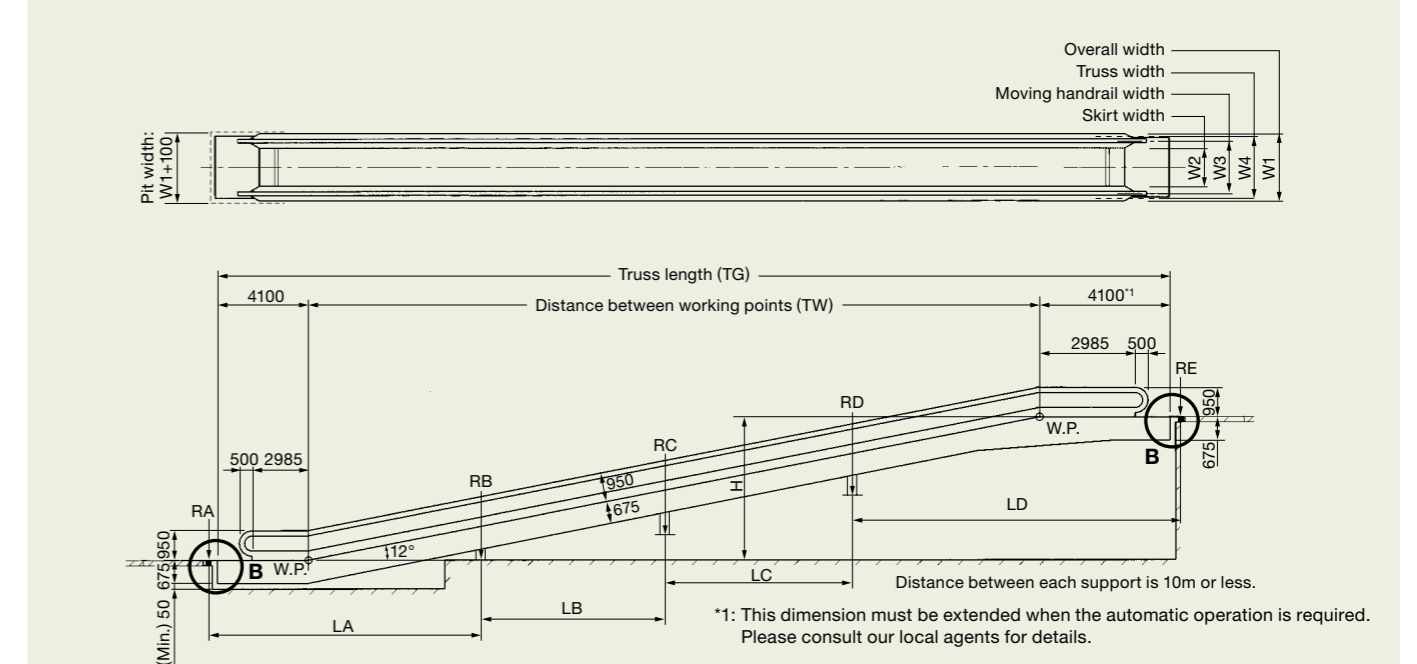

\*1: This dimension must be extended when the automatic operation is required. Please consult our local agents for details.

### ● Motor (kW)

Model	Inclination angle (°)	Speed (m/min)	Rise H (m)							Remarks
			0	3	4	5	6	7		
1200	12	30			3.5	5.5kW×2			7	3.5 ≤ Rise ≤ 7

### ● Loads

RA (N)	$3.70 \times LA$
RB (N)	$3.70 \times (LA + LB)$
RC (N)	$3.70 \times (LB + LC)$
RD (N)	$3.70 \times (LC + LD)$
RE (N)	$3.70 \times LD$

(LA, LB, LC, LD: mm)

## ● Finishes

Balustrade	Interior panel	TP-E	Hairline-finished stainless-steel plate
		TS-E	Vertical, flat, rectangular tempered-glass panels without illumination
		TS-LE	Vertical, flat, rectangular tempered-glass panels with illumination
Treads	Deckboard	Hairline-finished stainless-steel plate	
	Skirt guard	Hairline-finished stainless-steel plate	
	Moving handrail	Synthetic rubber	
Treads	Tread boards	Diecast aluminum alloy with black painted grooves	
Floor plate	Comb	Molded aluminum alloy	
	Landing plate etc.	Stainless-steel plate with antislip pattern and black painted grooves	

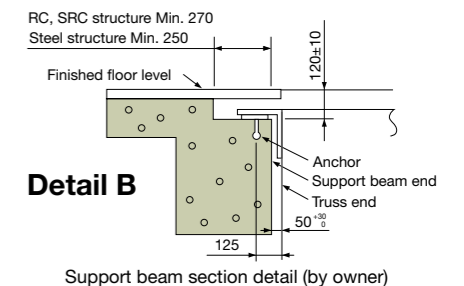

Support beam section detail (by owner)

## Ordering Information

- Name and address of building or project.
- Type of moving walk desired.
- Length of moving walk and angle of inclination.
- Number of units.
- Voltage and frequency of power source.
- Optional items desired.

## Work Not Included in the Installation Contract

- External finish work on moving walk.
- Intermediate support beam.
- Pit construction, waterproofing, drainage work, and other architectural work.
- Wiring and conduits for the main power and lighting lines to the control panel installed on a truss.
- Wiring and conduits for grounding.



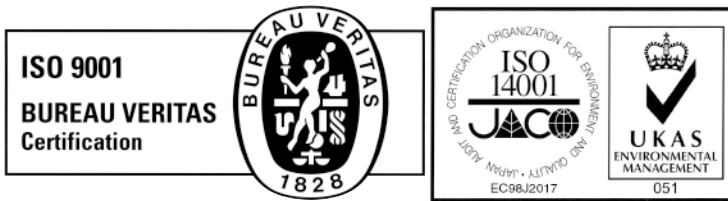

Mitsubishi Elevator Inazawa Works has acquired ISO 9001 certification from the International Organization for Standardization based on a review of quality management. The company has also acquired environmental management system standard ISO 14001 certification.



for a greener tomorrow

Eco Changes is the Mitsubishi Electric Group's environmental statement, and expresses the Group's stance on environmental management. Through a wide range of businesses, we are helping contribute to the realization of a sustainable society.

**MITSUBISHI ELECTRIC CORPORATION**  
 HEAD OFFICE : TOKYO BLDG., 2-7-3, MARUNOUCHI, CHIYODA-KU, TOKYO 100-8310, JAPAN

Visit our website at:  
<http://www.mitsubishielectric.com/elevator/>

**⚠ Safety Tips:** Be sure to read the instruction manual fully before using this product.

Revised publication, effective Jan. 2015.  
 Superseding publication of L-170-6-C2461-H Feb. 2012.  
 Specifications are subject to change without notice.

©2015 Mitsubishi Electric Corporation