

# INVERTER FAMILY

Making the future by supporting daily life



# GLOBAL IMPACT OF MITSUBISHI ELECTRIC



Through Mitsubishi Electric's vision, "Changes for the Better" are possible for a brighter future.

## ***Changes for the Better***

"Changes for the Better" represents the Mitsubishi Electric Group's attitude to "always strive to achieve something better", as we continue to change and grow. Each one of us shares a strong will and passion to continuously aim for change, reinforcing our commitment to creating "an even better tomorrow".

Mitsubishi Electric is involved in many areas including the following:

### **Energy and Electric Systems**

A wide range of power and electrical products from generators to large-scale displays.

### **Electronic Devices**

A wide portfolio of cutting-edge semiconductor devices for systems and products.

### **Home Appliance**

Dependable consumer products like air conditioners and home entertainment systems.

### **Information and Communication Systems**

Commercial and consumer-centric equipment, products and systems.

### **Industrial Automation Systems**

Maximizing productivity and efficiency with cutting-edge automation technology.

Our advances in AI and IoT are adding new value to society in diverse areas from automation to information systems. The creation of game-changing solutions is helping to transform the world, which is why we are honored to be recognized in the 2019 "Forbes Digital 100" as one of world's most influential digital corporations.



Established February 2nd 1921 Mitsubishi Electric celebrates 100 years of serving society through practical, innovative technology solving the issues of the day.



<b>Main features of the 800/700 series</b>	<b>6</b>
<b>FR-A800 Series</b>	<b>8</b>
<b>FR-A800 Plus Series</b>	<b>10</b>
<b>FR-F800 Series</b>	<b>13</b>
<b>FR-E800 Series</b>	<b>14</b>
<b>FR-E700 Series</b>	<b>16</b>
<b>FR-F700PJ Series</b>	<b>17</b>
<b>FR-D700 Series</b>	<b>18</b>
<b>FR-A701 Series</b>	<b>19</b>
<b>FR-CC2 Series</b>	<b>20</b>
<b>FR-B Series</b>	<b>20</b>
<b>Option Series</b>	<b>21</b>
<b>Mitsubishi Electric Product Guide</b>	<b>27</b>
<b>List of Alternative Models for the Conventional Series</b>	<b>36</b>
<b>Warranty</b>	<b>38</b>

Mitsubishi Electric general-purpose inverters used

for various applications to support daily life







**A800 Plus**  **IM&IPM** **Ethernet**  
**Dedicated inverter for specialized field**  
**Application** Cranes, winding/unwinding machines, logistics/transport systems, and liquid cooled type

**A800**  **IM&IPM** **IP55** **Ethernet**  
**High performance and high functionality**  
**Application** Transfer systems, lifts, machine tools, presses, printing machines, ships, and tunnel boring machines

**FR-A800-P** **IM**  
**Parallel operation function compatible inverter**  
 Enlarged range of applicable motor capacity

**F800**  **IM&IPM** **IP55** **Ethernet**  
**Enhanced next-generation energy-saving inverter**  
**Application** Fans, pumps, and air conditioning systems

**E800**  **IM&IPM** **Ethernet**  
**Compact, high functionality inverter**  
**Application** Transfer systems, lifts, food packaging machines, machine tools, presses, and printing machines

**FR-D700**  **IM**  
**Simple and compact inverter**  
**Application** Transfer systems, lifts, food packaging machines, machine tools, air conditioning systems, fans, and pumps

Function/performance

# Main features of the 800/700 series\*1



## Energy saving

Compared to commercial power supply operation, significant energy savings can be gained by decreasing the rotation speed.

Inverter models that support the following motors are available.

- General-purpose motor with IE3 premium efficiency (SF-PR)
- IPM motor equivalent to IE4 super premium efficiency (MM-EFS)

(For motor efficiency comparison, refer to page 27.)

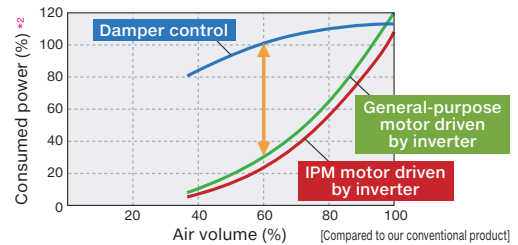

## Equipment maintenance

Equipment downtime will be reduced by using the predictive/preventive maintenance functions for inverters and peripheral devices, as well as using the inverter's diagnosis function.

- Life diagnosis function  
The remaining life can be estimated for parts such as the main circuit capacitor, control circuit capacitor, and inrush current limit circuit by checking the deterioration.
- Load characteristics fault detection function / output current detection function  
When a mechanical fault occurs during conveyor/fan/pump operation, the inverter outputs a warning or shuts off the output to prevent system damage.
- Maintenance timer / start count monitor  
Monitoring the operating hours contributes to preventive maintenance.



## IoT

Real-time connection with the host IT system enables centralized or remote monitoring of operation, which further streamlines the production.

- CC-Link IE TSN  
Real-time production data collection is enabled by high-speed, stable communication.
- Multi-protocols supported  
Multi-protocol inverters and communication options are available to support major global industrial Ethernet/field networks, achieving greater flexibility and facilitating maintenance and technical support.



\*1: Refer to the inverter catalogs to check which function is available for the applicable inverter.  
\*2: Rated motor output is 100%.

## Capacity table

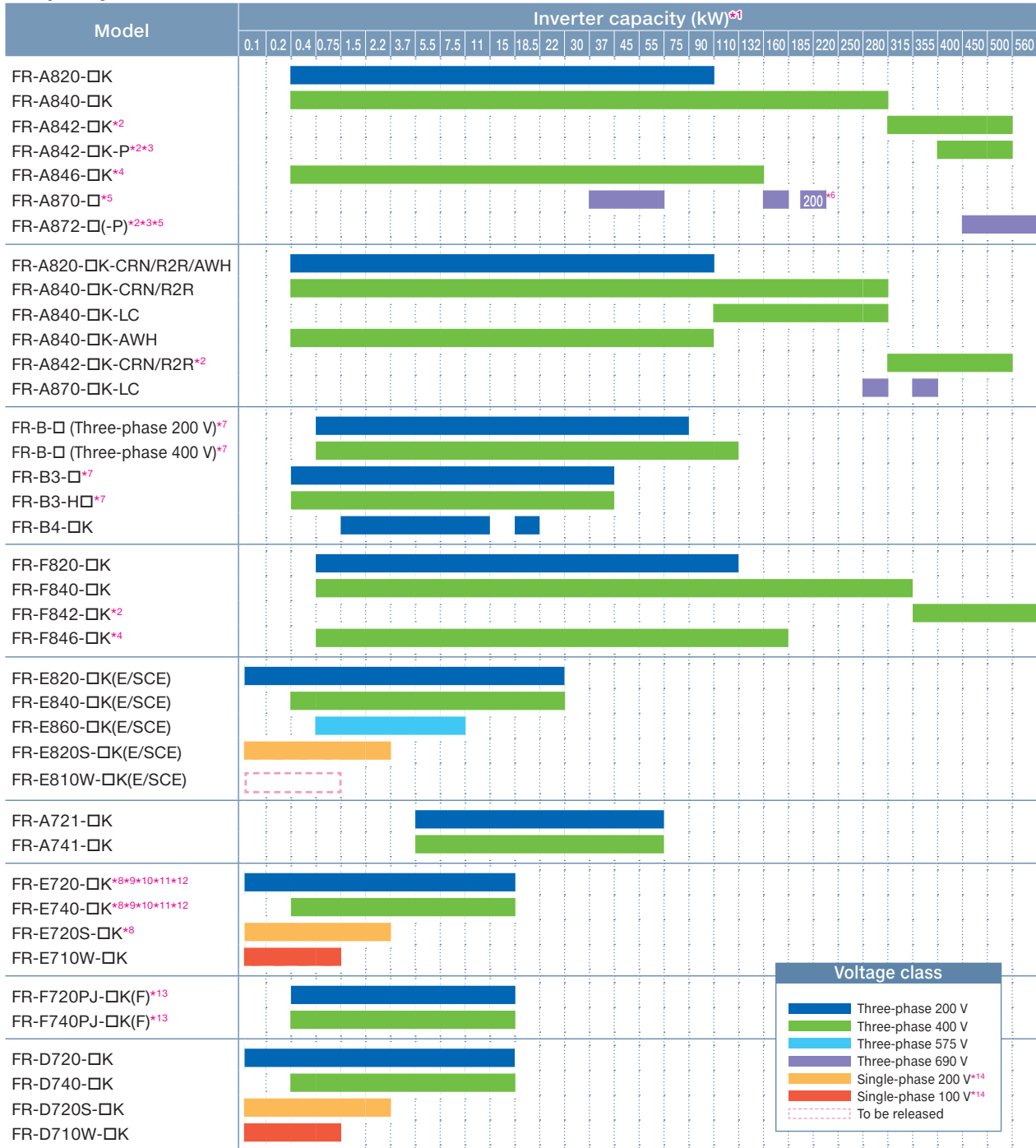

<sup>\*1</sup>: ND rated capacity for the FR-A800/E800 series, and LD rated capacity for the FR-F800 series.  
<sup>\*2</sup>: Separated converter type. Always install the converter unit (FR-CC2(-P)). (Not required when a high power factor converter (FR-HC2) is used.)  
<sup>\*3</sup>: Parallel operation function compatible inverter can drive a motor whose capacity is 80% of the total capacity of the inverters connected in parallel (maximum three units).  
<sup>\*4</sup>: IP55 compatible model.  
<sup>\*5</sup>: Rated current (SLD rating) is indicated in the model name.  
<sup>\*6</sup>: This indicates that the applicable motor capacity in ND rating is 200 kW.  
<sup>\*7</sup>: Capacity is indicated in watt (W) in the model name when the inverter capacity is less than 3.7 kW.

<sup>\*8</sup>: SC at the end of the model name indicates the safety stop function model.  
<sup>\*9</sup>: NF at the end of the model name indicates the FL remote communication model.  
<sup>\*10</sup>: NC at the end of the model name indicates the CC-Link communication model.  
<sup>\*11</sup>: -NE at the end of the model name indicates the Ethernet communication function model.  
<sup>\*12</sup>: -TM at the end of the model name indicates the dedicated EtherCAT communication model.  
<sup>\*13</sup>: Filterpack (FR-BFP2) is enclosed for the inverter with Filterpack. ("F" is marked at the end of its model names on the packaging box.)  
<sup>\*14</sup>: The output to motors of the single-phase 200 V and single-phase 100 V input models is three-phase 200 V.

For more information,  
check the Mitsubishi Electric  
FA Global Website.

Product  
video



Catalogs  
and leaflets



High performance and high functionality inverter

# FR-A800 Series

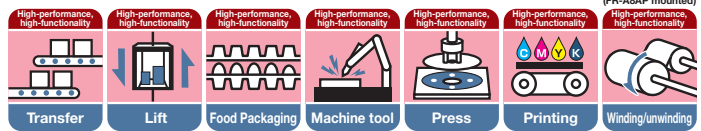

## Features

### Leading drive performance

- The enhanced Real sensorless vector control and vector control achieves improved speed response and high-speed operation.
- The PM motor auto tuning function enables operation of other manufacturers' permanent magnet (PM) motors.

### Security & safety

- Controls with safety functions can be easily performed. (Safety stop function)
- 24 VDC control power input is equipped as standard. The parameter setting and communication operation can be done without turning ON the main power.
- The operating status immediately before the protective function is activated can be stored with the trace function, facilitating the trouble analysis at a separate location by using a USB memory device and the inverter setup software (FR Configurator2).

### Easy setup & easy to use

- A USB host connector (A type) is equipped. Parameters can be copied to commercial USB memory devices.
- Highly reliable and easily wired spring clamp terminals have been adopted for control circuit terminals.
- Parameter setting mode can be changed to the group parameter mode, which provides intuitive and simple parameter settings. (The conventional parameter setting mode is selected by default.)

### Eco-friendly factories

- With Optimum excitation control, the excitation current is constantly adjusted to drive the motor in the most efficient method which leads to energy saving.
- The 315K or higher models are inverter-converter separated types, which are suitable for power regeneration. Select the FR-CC2 converter unit according to the connected motor capacity (refer to page 20).



### System support

- Rated current and four different overload capacity ratings (SLD rating, LD rating, ND rating, and HD rating) can be selected with parameters. (Multiple rating)
- Parameters and setting frequency can be changed at the program, and the inverter control based on the machine specifications is possible by the PLC function.

### Environmental adaptability

- A built-in noise filter (EMC filter), the newly developed drive technology, and the power supply technology minimize the EMI emitted from inverters.
- For the 400 V class, compliance with various countries ship classifications allows use on ship equipment. (For details of the certified models, refer to Mitsubishi Electric FA Global Website ([www.MitsubishiElectric.co.jp/fa](http://www.MitsubishiElectric.co.jp/fa)).

## Supporting Ethernet communication Integrated communication function

### FR-A800-GN CC-Link IE TSN

With the CC-Link IE TSN (Time Sensitive Networking) communication function, data can be transmitted to IT systems while performing real-time cyclic communication control.

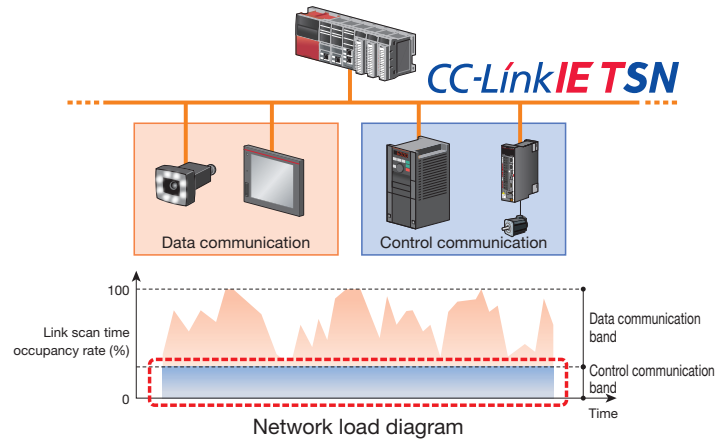

### FR-A800-E CC-Link IE Field Basic

The CC-Link IE Field Network Basic enables easy development of network communication using the general-purpose Ethernet-based technology. The integrated Ethernet communication function enables monitoring of the inverter's status or setting of parameters via Internet.

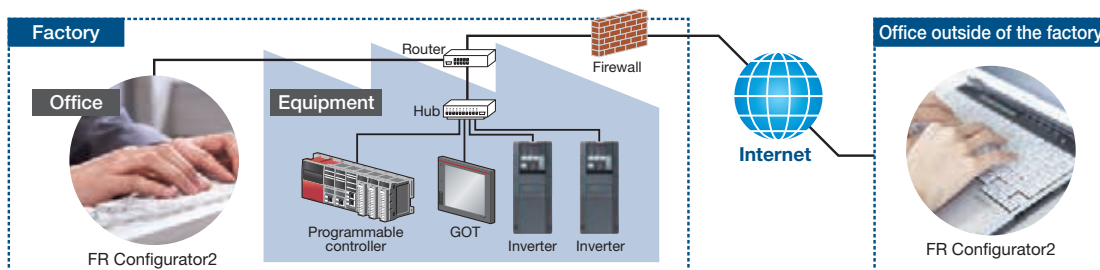



**Direct installation near the machine** IP55 compatible

**FR-A846**

As the FR-A846 (IP55 compatible model) inverter offers waterproof and dustproof performance with a highly protective structure, it can be installed near the machine.

- Compatibility with hostile environments such as high humidity and dusty environments widens the range of locations for installation.
- With a DC reactor inside the inverter, less wiring and smaller space are required.

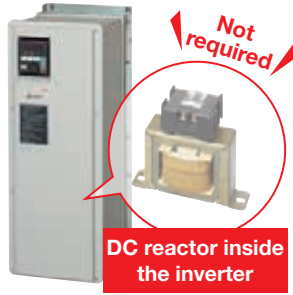

**IP 55**

•First digit (protection rating against solid objects)		•Second digit (protection rating against water)	
IP rating	Description	IP rating	Description
Class 5	Protection against dust. No ingress of dust that may inhibit normal operation.	Class 5	Protection against water jets from all directions.

**Enlarged range of applicable motor capacity**  
Parallel operation

**FR-A842-P/FR-A872-P, FR-CC2-P/FR-CC2-N-P**

Motors up to 1350 kW can be driven by operating the inverters (FR-A842-P/FR-A872-P) and converter units (FR-CC2-P/FR-CC2-N-P) in parallel, enhancing the application to larger scale systems. Parallel operation of up to three inverters and three converter units is possible without increasing the size of the inverter or converter unit, facilitating installation into the enclosure.

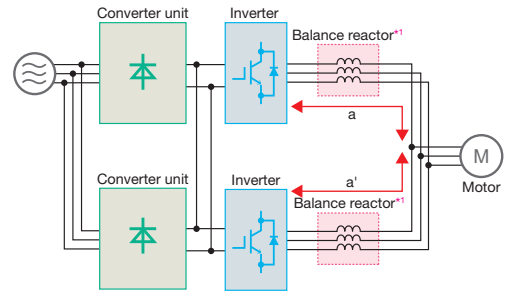

\*1: When the cable length from an inverter to each node point (a or a') is less than 10 m, install the balance reactor.

**Model**

FR - A 8 **20** - **0.4K** - - -

Symbol	Voltage class	Symbol	Structure, functionality	Symbol <sup>6)</sup>	Description	Symbol	Type	Communication type	Symbol	Circuit board coating (IEC60721-3-3:1994 3C2/3S2 compatible)	Plated conductor	Symbol	Function
2	200 V class	0	Standard model <sup>3)</sup>	0.4K to 560K	Inverter ND rated capacity (kW)	1	FM	RS-485	None <sup>5)</sup>	Without	Without	None	Standard type
4	400 V class	2	Separated converter type <sup>4)</sup>			2	CA <sup>2)</sup>	Ethernet	60	With	Without	GN	CC-Link IE TSN functionality
7	690 V class <sup>7)</sup>	6	IP55 compatible model			E1	FM		E2	CA <sup>2)</sup>	With	With	GF
				M	Slim model							P	Parallel operation

Inverter model	Inverter capacity (ND rated)
FR-A820(-E)(-GF)(-GN)	0.4 kW to 90 kW
FR-A840(-E)(-GF)(-GN)	0.4 kW to 280 kW
FR-A842(-E)(-GF)(-GN)	315 kW to 500 kW
FR-A842-P	400 kW to 500 kW
FR-A846(-E)	0.4 kW to 132 kW
FR-A840M(-E)	160 kW, 200 kW
FR-A870-E	37 kW to 55 kW, 160 kW, 200 kW
FR-A872-E	450 kW to 560 kW
FR-A872-P	450 kW to 560 kW

- \*1: IP55 compatible models have LD and ND rating types only. However, the SLD rated current of standard models is used to represent the model.
- \*2: For the CA-type, the monitor output terminal FM/CA operates as terminal CA (analog current output 0 to 20 mA DC), not as terminal FM (pulse train output).
- \*3: For the 75K or higher inverter and a 75 kW or higher motor, always connect a DC reactor (FR-HEL), which is available as an option. Select a DC reactor according to the applied motor capacity. (Except for models with a built-in DC reactor)
- \*4: Always install the converter unit (FR-CC2(-P)). (Not required when a high power factor converter (FR-HC2) is used)
- \*5: Available for the 5.5K or higher.
- \*6: Applicable to the standard structure model or the separated converter type.
- \*7: The insulation distance conforms to IEC 61800.

**Specifications (standard type)**

Control method	Soft-PWM control, high carrier frequency PWM control (selectable among V/F control, Advanced magnetic flux vector control, Real sensorless vector control), Optimum excitation control, vector control <sup>1)</sup> , and PM sensorless vector control																					
Starting torque	SLD rating: 120% 0.3 Hz, LD rating: 150% 0.3 Hz, ND rating: 200% <sup>2)</sup> 0.3 Hz, HD rating: 250% <sup>2)</sup> 0.3 Hz (under Real sensorless vector control) SLD rating: 120% 0 Hz, LD rating: 150% 0 Hz, ND rating: 200% <sup>2)</sup> 0 Hz, HD rating: 250% <sup>2)</sup> 0 Hz (under Vector control <sup>1)</sup> )																					
Output frequency range	0.2 to 590 Hz (Up to 400 Hz with Advanced magnetic flux vector control, Real sensorless vector control, vector control <sup>1)</sup> or PM sensorless vector control)																					
Regenerative braking torque <sup>3)</sup> (ND rating)	<table border="1"> <thead> <tr> <th>Maximum value/ permissible duty</th> <th>200 V class<sup>4)</sup>: 0.4K to 1.5K</th> <th>150%3%ED</th> <th>2.2K/3.7K</th> <th>100%3%ED</th> <th>5.5K/7.5K</th> <th>100%2%ED</th> </tr> </thead> <tbody> <tr> <td></td> <td>11K to 55K</td> <td>20% continuous</td> <td>75K or higher</td> <td>10% continuous</td> <td></td> <td></td> </tr> <tr> <td></td> <td>400 V class<sup>5)</sup>: 0.4K to 7.5K</td> <td>100%2%ED</td> <td>11K to 55K</td> <td>20% continuous</td> <td>75K or higher</td> <td>10% continuous</td> </tr> </tbody> </table>	Maximum value/ permissible duty	200 V class <sup>4)</sup> : 0.4K to 1.5K	150%3%ED	2.2K/3.7K	100%3%ED	5.5K/7.5K	100%2%ED		11K to 55K	20% continuous	75K or higher	10% continuous				400 V class <sup>5)</sup> : 0.4K to 7.5K	100%2%ED	11K to 55K	20% continuous	75K or higher	10% continuous
Maximum value/ permissible duty	200 V class <sup>4)</sup> : 0.4K to 1.5K	150%3%ED	2.2K/3.7K	100%3%ED	5.5K/7.5K	100%2%ED																
	11K to 55K	20% continuous	75K or higher	10% continuous																		
	400 V class <sup>5)</sup> : 0.4K to 7.5K	100%2%ED	11K to 55K	20% continuous	75K or higher	10% continuous																
Acceleration/deceleration time setting	0 to 3600 s (up to three types of accelerations and decelerations can be set individually.)																					
Multi-speed	15 speeds																					
Speed command	0 to 5 VDC, 0 to 10 VDC, 0 to ±5 VDC, 0 to ±10 VDC, 4 to 20 mA, digitally set with pulse train input, operation panel or parameter unit, 4-digit BCD or 16-bit binary (when using optional FR-A8AX)																					
Alarm output	1 changeover contact (230 VAC, 0.3 A, 30 VDC, 0.3 A), open collector output, alarm code (4-bit) output																					
Output signal	Five types of open collector outputs and two types of contact output (1 changeover contact) can be selected from inverter running, up to frequency, frequency detection, operation ready, overload warning, error output and alarm, etc.																					
Monitor function	One type can be selected from output frequency, motor current (steady or peak value), output voltage, operation speed, motor torque, converter output voltage, regenerative brake duty, input power, output power and load meter, etc. Pulse train output (1440 pulses/s, 2 mA) and analog output (-10 to 10 VDC)																					
Restart after instantaneous power failure	Available (frequency search method, reduced voltage method)																					
Removable terminal block	Used for control circuit terminals																					
Communication function	Communication supported as standard: RS-485 (Mitsubishi inverter protocol, MODBUS <sup>®</sup> RTU <sup>6)</sup> ) or Ethernet <sup>6)</sup> . Communication supported when the compatible option is used: CC-Link, CC-Link IE Field Network, CC-Link IE TSN, PROFIBUS-DP, DeviceNet <sup>™</sup> , SSCNET III(H), or FL remote communication.																					

- \*1: Vector control is available when a Vector control compatible option is installed.
- \*2: In the initial setting for the FR-A820-00340(5.5K) or higher and the FR-A840-00170(5.5K) or higher, the starting torque is limited to 150% by the torque limit level.
- \*3: The regenerative braking torque indicates the average short-time torque (which varies by the motor loss) that is generated when a motor decelerates in the shortest time by itself from the rated speed. When a motor decelerates from a speed higher than the rated speed, the average deceleration torque decreases. When the regenerative power is large, use an option brake unit.
- \*4: The following performance can be attained when FR-ABR (option) is connected: 150% torque and 10%ED for 0.4K and 0.75K, 100% torque and 10%ED for 1.5K to 7.5K, 100% torque and 6%ED for 11K to 22K.
- \*5: The following performance can be attained when FR-ABR-H (option) is connected: 100% torque and 10%ED for 0.4K and 0.75K, 100% torque and 6%ED for 11K to 22K.
- \*6: Availability depends on the communication type of the inverter specifications.

Dedicated inverter for specialized field

# FR-A800 Plus Series

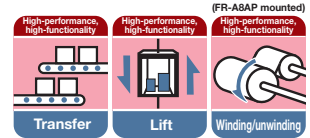

## Features

### Pursuing optimum functions to meet our customers' needs

A lineup of dedicated inverters for specialized fields are offered. Plus! The optimum functions for each dedicated field are added to the already high performance and high functionality FR-A800 series inverter.



### Optimum functions for cranes FR-A800-CRN



#### Reduction in tact time

By using the Mitsubishi Electric's original anti-sway control technology, the swinging of an object moved by a crane is suppressed at the time of stopping, even without operator's input adjustment. This control cuts down the tact time and facilitates efficient operation.

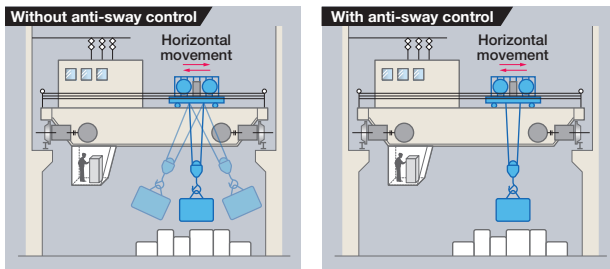

#### Load slippage prevention

- The highly scalable brake sequence function enables the output of a brake opening signal for the optimum brake operation calculated from the load torque or the speed.
- Slippage during the start of a lift can be checked. (A speed detector such as an encoder is required.)

#### Dedicated monitoring functions

- A signal can be output when too much load is applied.
- The inverter starting times can be counted to determine the timing of the maintenance.

### Optimum functions for roll to roll applications FR-A800-R2R



#### Winding/unwinding shaft

Tension control (speed control / torque control) is enabled by inputting the dancer roll position or the feedback from the tension sensor. Stable control can be achieved by winding diameter calculation, even with a large difference between the maximum and minimum diameters.

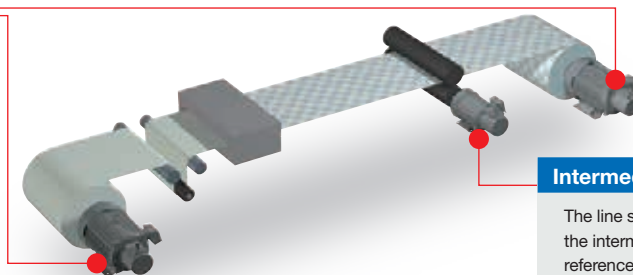

#### Intermediate shaft

The line speed is controlled by driving the intermediate shafts such as a reference shaft with a constant winding diameter or the feeding shaft.

#### System simplification

The FR-A800-R2R inverter has various dedicated functions for dancer control and tension control (winding diameter calculation, etc.), providing stable winding/unwinding control independently.

#### Easy startup and adjustment

Mechanical adjustment according to applications can be achieved just by setting parameters, which enables the startup and adjustment work of the system by the inverter alone. (PI gain automatic adjustment function)

#### Wide range of applications

The inverter offers four types of control functions which enables the use in various system applications such as winding/unwinding in the wire drawing machines and printers.

- Dancer feedback speed control
- Tension sensor feedback speed control
- Tension sensorless torque control
- Tension sensor feedback torque control



**Liquid Cooled Type Inverter** FR-A800-LC

**Effective solution for downsizing of the enclosure**

A smaller enclosure can be used since the quantity of the heat dissipated in the enclosure is reduced.

**Dedicated monitoring functions**

A sensor (flow switch) is attached at the inlet of coolant to send a signal to the inverter. When the coolant flow rate decreases, a warning is output, enabling quick, direct detection of system faults.

**Lineup of 690 V class inverters**

The power supply voltage of 690 VAC is supported. A wider range of power supply voltage is covered.

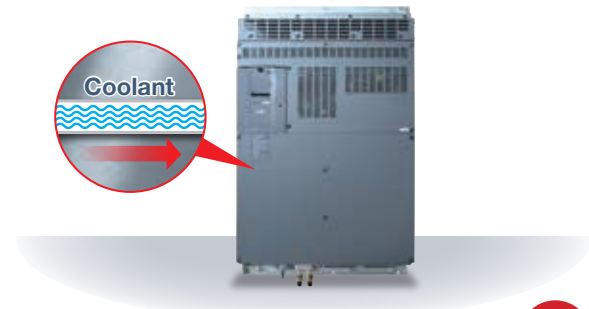

**Logistics/Transport Dedicated Inverter** FR-A800-AWH

**Full-closed control**

This function is used to operate logistics/transport equipment in combination with distance meters and the host controller. The logistics/transport equipment is moved while position loop is compensated by inputting the feedback of the position detected by the distance meter.

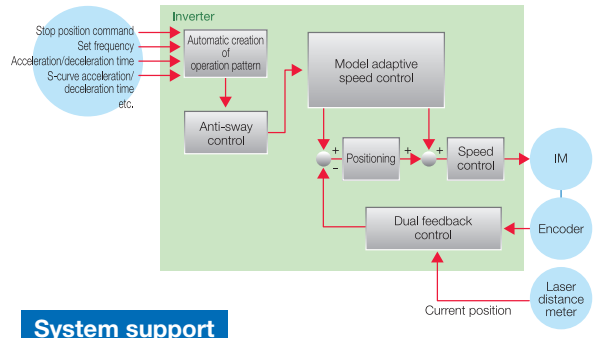

**Reducing tact time**

**Anti-sway control**

This function minimizes the swinging of the crane frame while the shuttle car is traveling. This will contribute to tact time reduction as less time is required for the swinging to stop.

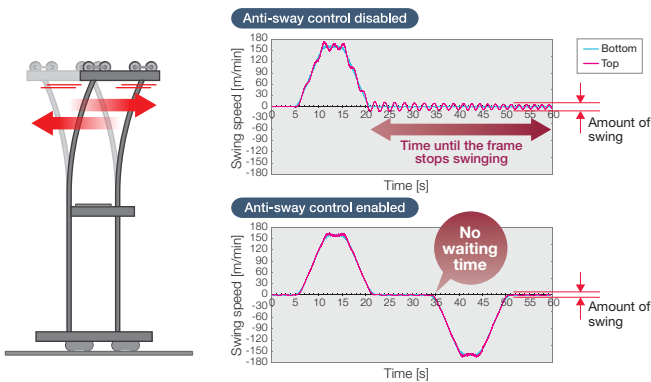

**System support**

**Network**

The master gives the start command, speed command, or stop position command to the inverters through communication for the driving control.

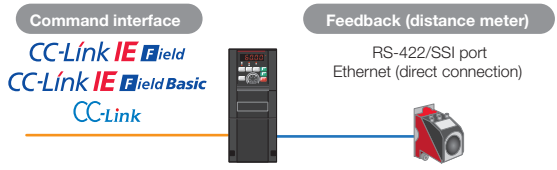

Type	Network	Remarks
Command interface	CC-Link IE Field	When used with FR-A8NCE
	CC-Link IE Field Basic	Ethernet models only
	CC-Link	When used with FR-A8NC
Feedback (distance meter)	RS-422	RS-485 models only
	Ethernet	Ethernet models only
	SSI	When used with FR-A8APS-02

# Model

## ■ Optimum functions for cranes FR-A800-CRN



FR - A 8 **20** - **0.4K** - **1** - **60** **CRN**

Symbol	Voltage class	Symbol	Structure/function	Capacity <sup>1)</sup>	Description	Symbol	Type	Communication type	Symbol	Circuit board coating (IEC60721-3-3: 1994 3C2/3S2 compatible)	Plated conductor	Symbol	Dedicated function
2	200 V class	0	Standard model <sup>3)</sup>	0.4K to 500K	Inverter ND rated capacity (kW)	1	FM	RS-485	60	With	Without	CRN	Crane dedicated model
4	400 V class	2	Separated converter type			2	CA <sup>2)</sup>		06 <sup>3)</sup>		With		
						E1	FM	Ethernet	61		Without		
						E2	CA <sup>2)</sup>		16 <sup>3)</sup>		With		

Inverter model	Inverter capacity
FR-A820	0.4 kW to 90 kW
FR-A840	0.4 kW to 280 kW
FR-A842	315 kW to 500 kW

- \*1: Models can be alternatively indicated with the inverter rated current (SLD rating).
- \*2: For the CA type, the monitor output terminal F/C operates as terminal CA (analog current output: 0 to 20 mA DC), not as terminal FM (pulse train output).
- \*3: Available for the 5.5K or higher.
- \*4: For the 75K or higher inverter, or whenever a 75 kW or higher motor is used, always connect a DC reactor (FR-HEL), which is available as an option.

## ■ Optimum functions for roll to roll applications FR-A800-R2R



FR - A 8 **20** - **0.4K** - **E1** - **R2R**

Symbol	Voltage class	Symbol	Structure/function	Capacity <sup>1)</sup>	Description	Symbol	Type	Communication type	Symbol	Circuit board coating (IEC60721-3-3: 1994 3C2/3S2 compatible)	Plated conductor	Symbol	Dedicated function
2	200 V class	0	Standard model <sup>3)</sup>	0.4K to 500K	Inverter ND rated capacity (kW)	1	FM	RS-485	None	Without	Without	R2R	Roll to roll dedicated model
4	400 V class	2	Separated converter type			2	CA <sup>2)</sup>		60	With	With		
						E1	FM	Ethernet	06 <sup>3)</sup>	With	With		
						E2	CA <sup>2)</sup>						

Inverter model	Inverter capacity
FR-A820	0.4 kW to 90 kW
FR-A840	0.4 kW to 280 kW
FR-A842	315 kW to 500 kW

- \*1: Models can be alternatively indicated with the inverter rated current (SLD rating).
- \*2: For the CA type, the monitor output terminal F/C operates as terminal CA (analog current output: 0 to 20 mA DC), not as terminal FM (pulse train output).
- \*3: Available for the 5.5K or higher.
- \*4: For the 75K or higher inverter, or whenever a 75 kW or higher motor is used, always connect a DC reactor (FR-HEL), which is available as an option.

## ■ Liquid Cooled Type Inverter FR-A800-LC



FR - A 8 **40** - **280K** - **1** - **LC**

Symbol	Voltage class	Voltage class	Symbol	Description	Symbol	Type	Communication type	Symbol	Circuit board coating (IEC60721-3-3: 1994 3C2/3S2 compatible)	Plated conductor	Symbol	Function
4	400 V class	400 V class	110K to 280K	Inverter ND rated capacity (kW)	1	FM	RS-485	None	Without	Without	LC	Liquid cooled type
7	690 V class	690 V class	03250 to 06830	Inverter rated current (SLD rated current of the standard FR-A800 inverter) (A)	2	CA <sup>1)</sup>		60	With	With		
			280K, 355K	Inverter ND rated capacity (kW)	E1	FM	Ethernet	06	With	With		
			03590, 04560	Inverter SLD rated current (A)	E2	CA <sup>1)</sup>						

- \*1: For the CA type, the monitor output terminal F/C operates as terminal CA (analog current output: 0 to 20 mA DC), not as terminal FM (pulse train output).

## ■ Logistics/Transport Dedicated Inverter FR-A800-AWH



FR - A 8 **20** - **0.4K** - **1** - **AWH**

Symbol	Voltage class	Symbol <sup>1)</sup> 04	Description	Symbol	Type	Communication type	Symbol	Circuit board coating (IEC60721-3-3: 1994 3C2/3S2 compatible)	Plated conductor	Symbol	Function
2	200 V class	0.4K to 90K	Inverter ND rated capacity (kW)	1	FM	RS-485	None	Without	Without	AWH	Logistics/transport model
4	400 V class			2	CA <sup>2)</sup>		60	With	With		
				E1	FM	Ethernet	06 <sup>3)</sup>	With	With		
				E2	CA <sup>2)</sup>						

Inverter model	Inverter capacity
FR-A820	0.4 kW to 90 kW
FR-A840	0.4 kW to 90 kW

- \*1: Models can be alternatively indicated with the inverter rated current (SLD rating).
- \*2: For the CA-type, the monitor output terminal FM/CA operates as terminal CA (analog current output 0 to 20 mA DC), not as terminal FM (pulse train output).
- \*3: Available for the 5.5K or higher.
- \*4: For the 75K or higher inverter, or whenever a 75 kW or higher motor is used, always connect a DC reactor (FR-HEL), which is available as an option.

Enhanced next-generation  
energy-saving inverter

# FR-F800 Series

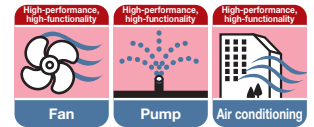

## Features

### Energy saving

- Advanced optimum excitation control, which has been newly developed, provides a large starting torque while maintaining the motor efficiency under the conventional Optimum excitation control.
- The tuning function enables operation of other manufacturers' induction motors and PM motors, which increases the use in the energy saving applications.

### Functions ideal for fans and pumps

- The rating can be selected between the two types (LD (light duty) or SLD (superlight duty)) depending on the load of the fan/pump to be used (multiple rating).
- The inverter can perform PID control of the motor operation and control the external equipment at the same time (PID multiple loops). The system cost can be reduced.
- By controlling the pumps connected in parallel (up to four pumps) by the PID control, water volume, etc. can be adjusted by one inverter (multi-pump function).
- The integrated Ethernet communication function of the FR-F800-E inverter enables monitoring of the inverter's status or setting of parameters via Internet.

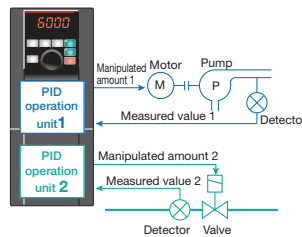

### Security & safety

- The inverter is equipped with a temperature sensor, which outputs a signal when the internal temperature is high.

### Compatibility with the environment

- A built-in noise filter (EMC filter) minimizes the EMI emitted from inverters.
- By installing a DC reactor (FR-HEL), which is available as an option, they can conform to the Architectural Standard Specifications supervised by the Ministry of Land, Infrastructure, Transport and Tourism of Japan.

## Model

FR - F 8 **2 0** - **0.75K** - **1** -   

Symbol	Voltage class
2	200 V class
4	400 V class

Symbol	Structure, functionality
0	Standard model*3
2	Separated converter type*4
6	IP55 compatible model

Symbol <sup>5</sup>	Description
0.75K	Inverter LD rated capacity (kW)
00023	Inverter SLD rated to 06830 current (A)

Symbol	Type	Communication type
1	FM	RS-485
2	CA*2	
E1	FM	Ethernet
E2	CA*2	

Symbol	Circuit board coating (IEC60721-3-3: 1994 3C2/3S2 compatible)	Plated conductor
None*5	Without	Without
60	With	Without
06*5	With	With

Inverter model	Inverter capacity
FR-F820(-E)	0.75 kW to 110 kW
FR-F840(-E)	0.75 kW to 315 kW
FR-F842(-E)	355 kW to 560 kW
FR-F846(-E)	0.75 kW to 160 kW

- \*1: IP55 compatible models have LD and ND rating types only. However, the SLD rated current of standard models is used to represent the model.
- \*2: For the CA-type, the monitor output terminal FM/CA operates as terminal CA (analog current output 0 to 20 mADC, not as terminal FM (pulse train output)).
- \*3: For the 75K or higher inverter, always connect a DC reactor (FR-HEL), which is available as an option. Select a DC reactor according to the applied motor capacity.
- \*4: Always install the converter unit (FR-CC2). (Not required when a high power factor converter (FR-HC2) is used)
- \*5: Available for the 7.5K or higher.
- \*6: Applicable to the standard structure model or the separated converter type.

## Specifications

Control method	Soft-PWM control, high carrier frequency PWM control (selectable among V/F control (Optimum excitation control), Advanced magnetic flux vector control (Advanced optimum excitation control), and PM motor control)	
Starting torque	Induction motor	120% 0.5 Hz (Advanced magnetic flux vector control)
	IPM motor	50%
Output frequency range	0.2 to 590 Hz (Up to 400 Hz with Advanced magnetic flux vector control, and PM motor control.)	
Regenerative braking torque (Maximum value/permissible duty)	Induction motor	0.75K to 55K...15% continuous, 75K or higher...10% continuous
	IPM motor	Approximately 5% (1.5K or lower...Approximately 10%)*1
Acceleration/deceleration time setting	0 to 3600 s (up to three types of accelerations and decelerations can be set individually.)	
Multi-speed	15 speeds	
Speed command	0 to 5 VDC, 0 to 10 VDC, 0 to ±5 VDC, 0 to ±10 VDC, 4 to 20 mA, pulse train input digitally set with operation panel or parameter unit, 4-digit BCD or 16-bit binary (when using optional FR-A8AX)	
Alarm output	1 changeover contact (230 VAC, 0.3 A, 30 VDC, 0.3 A), open collector output, alarm code (4-bit) output	
Output signal	Five types of open collector outputs and two types of contact outputs (1 changeover contact) can be selected from inverter running, up to frequency, frequency detection, operation ready, overload warning, error output and alarm, etc.	
Monitor function	One monitored item can be selected from output frequency, motor current (steady or peak value), output voltage, operation speed, converter output voltage, input power, output power and load meter, etc. Pulse train output (1440 pulses/s, 2 mA) and analog output (0 to 10 VDC)	
Restart after instantaneous power failure	Available (frequency search method, reduced voltage method)	
Removable terminal block	Used for control circuit terminals	
Communication function	Communication supported as standard: RS-485 (Mitsubishi inverter protocol, MODBUS <sup>®</sup> RTU <sup>2</sup> , BACnet <sup>®</sup> MS/TP) or Ethernet <sup>2</sup> . Communication supported when the compatible option is used: CC-Link, CC-Link IE Field Network, CC-Link IE TSN, PROFIBUS-DP, DeviceNet <sup>™</sup> , LonWorks <sup>®</sup> , or FL remote communication.	

\*1: Regenerative braking torque is the average short-time torque when a motor decelerates to a stop from the rated speed in the shortest time. (It varies with the motor loss.) It is not a continuous regenerative torque. The average deceleration torque decreases when a motor decelerates from a speed higher than the rated speed. When the regenerative power is large, use a braking option.

\*2: Availability depends on the communication type of the inverter specifications.

Compact, high functionality inverter  
**FR-E800 Series**

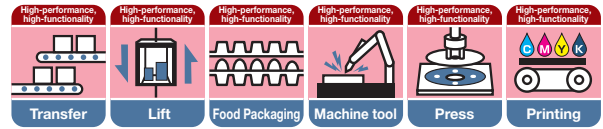

## Features

### Smart factory made possible through industrial IoT

#### CC-Link IE TSN supported as standard

Deterministic performance of cyclic communication is maintained even when mixed with slower information data (non real-time). This enables TCP/IP communication devices to be used without affecting overall control.



#### Compatibility with global networks

Inverter models that support protocols of major global industrial Ethernet networks are available.



CC-Link IE Field Basic

BACnet/IP, EtherCAT, MODBUS®/TCP

### Artificial intelligence (AI) supports users in various ways

#### AI fault diagnosis

AI technology of FR Configurator2 helps analyze and identify the cause of a fault when the inverter output is shut off. Diagnosable faults: Overcurrent trip and overvoltage trip (other faults will be supported in the future.)

This function is available during speed control.



#### Environmental impact diagnosis function

For the first time in the world<sup>1</sup>, the Corrosion-Attack-Level Alert System (CALAS™)<sup>2</sup> is integrated in the inverter. Damage caused by corrosive gas around inverters can be predicted, urging operators to improve the environment (for coated models (-60/-06) only).

<sup>1</sup>: As of September 2019 (according to our investigation)

<sup>2</sup>: Alert system for the risk of corrosive damage (degree of corrosion) of electrical equipment (Corrosion-Attack-Level Alert System)

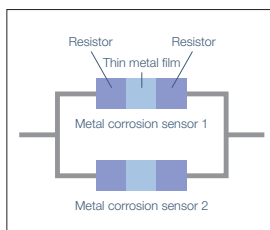

Schematic diagram of the metal corrosion sensor

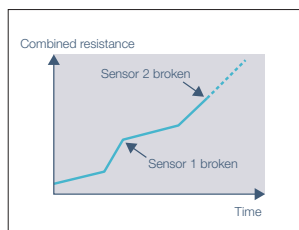

Example resistance value change detected by metal corrosion sensors



### Advanced harmony between humans and FA devices

#### Functional safety

The inverter is compliant with ISO 13849-1 and IEC 61508. This will contribute to reduction in the initial safety certification cost. Functional safety models are compliant with international standards for operation using the safely-limited speed (SLS) function and others with consideration taken to ensure human safety.

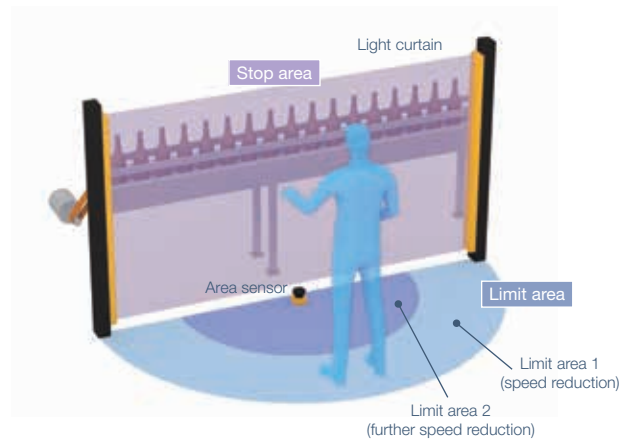

### Various solutions achieved by the outstanding drive performance

#### Position control

Vector control enables accurate transfer of glass or PET bottles to the filling position.

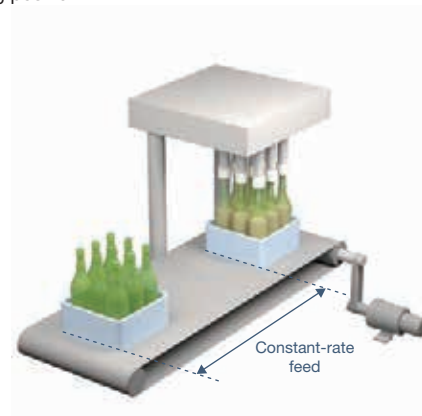

# Model

FR - E 8 **20** - **0.1K** - **1**

For the details of the lineup, please contact your sales representative.

Symbol	Voltage class
1 <sup>*5</sup>	100V
2	200V
4	400V
6	575V

Symbol	Structure, functionality
0	Standard

Symbol	Description
0.1K to 22K	Inverter ND rated capacity (kW)
0008 to 0900	Inverter ND rated current (A) <sup>†1</sup>

Symbol	Circuit board coating (IEC60721-3-3: 1994 3G2 compatible)	Plated conductor
None	Without	Without
-60	With	Without
-06 <sup>*3</sup>	With	With

Symbol	Number of phases
None	Three-phase input
S	Single-phase 200 V input
W <sup>*5</sup>	Single-phase 100 V input (double voltage rectification)

Symbol	Communication /functional safety specifications	Monitoring/protocol specifications	Rated frequency (initial setting)	Control logic (initial status)
-1	RS-485 + SIL2/PLd	Pulse (terminal FM)	60Hz	Sink logic
-4 <sup>†4</sup>		Voltage (terminal AM)	50Hz	Source logic
-5		Voltage (terminal AM)	60Hz	Sink logic
EPA	Ethernet + SIL2/PLd	Protocol group A <sup>*2</sup>	60Hz	Sink logic
EPB		Protocol group B <sup>*2</sup>	50Hz	Sink logic / Source logic <sup>*6</sup>
EPC		Protocol group C <sup>*2</sup>	50Hz	Sink logic / Source logic <sup>*6</sup>
SCEPA	Ethernet + SIL3/PLe	Protocol group A <sup>*2</sup>	60Hz	Source logic <sup>*7</sup>
SCEPB		Protocol group B <sup>*2</sup>	50Hz	Source logic <sup>*7</sup>
SCEPC <sup>*5</sup>		Protocol group C <sup>*2</sup>	50Hz	Source logic <sup>*7</sup>

<sup>†1</sup>: Models with circuit board coating (-60/-06) only.

<sup>\*2</sup>: Selectable protocols differ depending on the group.

Protocol group A: CC-Link IE TSN, CC-Link IE Field Network Basic, MODBUS/TCP, EtherNet/IP, and BACnet/IP

Protocol group B: CC-Link IE TSN, CC-Link IE Field Network Basic, MODBUS/TCP, and PROFINET

Protocol group C: EtherCAT

<sup>\*3</sup>: Available for the 11K or higher.

<sup>\*4</sup>: The kW indication is not available for models with a suffix "-4". When the kW indication is required, purchase the applicable model with a suffix "-5" and change the initial settings with reference to the Instruction Manual. (Refer to the Instruction Manual (Connection) for the switching of the control logic of the inverter, and the Instruction Manual (Function) for the rated frequency.)

<sup>\*5</sup>: To be released

<sup>\*6</sup>: The initial status of the control logic differs depending on the inverter model.

Sink logic for the models indicated with the rated capacity (kW)

Source logic for the models indicated with the rated current (A)

<sup>\*7</sup>: The control logic is fixed to the source logic.

Inverter model	Inverter capacity
FR-E820	0.1 kW to 22 kW
FR-E840	0.4 kW to 22 kW
FR-E860	0.75 kW to 7.5 kW
FR-E820S	0.1 kW to 2.2 kW
FR-E810W (to be released)	0.1 kW to 0.75 kW

# Specifications

Control method	Soft-PWM control, high carrier frequency PWM control (selectable among V/F control, Advanced magnetic flux vector control, Real sensorless vector control, Optimum excitation control, vector control <sup>†1</sup> , and PM sensorless vector control)
Starting torque	200% 0.3 Hz (3.7K or lower), 150% 0.3 Hz (5.5K or higher) with Real sensorless vector control
Output frequency range	0.2 to 590 Hz (Up to 400 Hz with Advanced magnetic flux vector control, Real sensorless vector control, vector control <sup>†1</sup> or PM sensorless vector control)
Regenerative braking torque <sup>*2</sup>	0.1K/0.2K.....150%, 0.4K/0.75K.....100%, 1.5K.....50%, 2.2K or higher.....20%
Acceleration/deceleration time setting	0 to 3600 s (up to two types of accelerations and decelerations can be set individually.)
Multi-speed	15 speeds
Speed command	0 to 5 VDC, 0 to 10 VDC, 4 to 20 mA, digital setting with setting dial, digital setting with operation panel or parameter unit, 4-digit BCD or 16-bit binary (when using optional FR-A8AX)
Safety monitoring functions	STO, SS1, SLS, SBC, SSM <sup>*3</sup>
Alarm output	1 changeover contact (250 VAC 2 A, 30 VDC 1 A), open collector output <sup>*4</sup>
Output signal	Two types of open collector outputs <sup>*4</sup> and one type of contact output (1 changeover contact) can be selected from inverter running, up to frequency, frequency detection, output current detection, operation ready, overload warning, fault output, and alarm, etc.
Monitor function	One monitored item can be selected from output frequency, motor current (steady or peak value), output voltage, frequency setting value, motor torque, converter output voltage, regenerative brake duty, and output power, etc. FM type: Pulse train output (1440 pulses/s 1 mA). AM type: Analog output (-10 to 10 VDC).
Restart after instantaneous power failure	Available (frequency search method, reduced voltage method)
Removable terminal block	Used for control circuit terminals
Communication function	Standard model: RS-485 (Mitsubishi inverter protocol, MODBUS <sup>®</sup> RTU) Ethernet model and safety communication model: Ethernet (CC-Link IE TSN, CC-Link IE Field Network Basic, MODBUS <sup>®</sup> /TCP, PROFINET, EtherNet/IP, BACnet/IP, and EtherCAT) Using options: CC-Link, PROFIBUS-DP, DeviceNet <sup>™</sup> , LonWorks <sup>®</sup>

<sup>†1</sup>: Vector control is available when a Vector control compatible option is installed.

<sup>\*2</sup>: Braking torque is the average short-time torque when a motor decelerates to a stop from 60 Hz in the shortest time. (It varies with the motor loss.) It is not a continuous regenerative torque.

The average deceleration torque becomes lower when a motor decelerates from a frequency higher than the base frequency.

Use an option brake resistor for an operation with large regenerative power. Brake unit can be also used. (Not available for 0.1K and 0.2K.)

<sup>\*3</sup>: SS1, SLS, SBC, and SSM are available for the standard model only.

<sup>\*4</sup>: Open collector output is not available for the Ethernet model and safety communication model.

Simple, powerful, and compact inverter

# FR-E700 Series

Ethernet

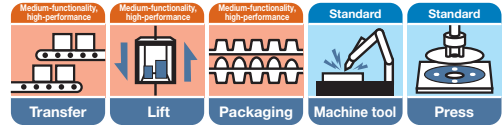

## Features

### Pursuing the best performance—top level of driving performance in a compact body

- Advanced magnetic flux vector control enables accurate start-ups for general-purpose industrial machines. (200% 0.5 Hz (3.7K or lower))
- Improved short-time permissible overload (200% for 3s) provides powerful and consistent driving.
- Torque limit and current limit functions are available.

### Easy-to-use (Diverse expandability)

- Plug-in options are available to add digital inputs/analog outputs and to support different communication networks.
- For the customers who need more than the standard terminals, the option terminal blocks, such as the 2-port RS-485 terminal block, are available.
- The FR-E700-NE (Ethernet enabled) is now available. CC-Link IE Field Network Basic is supported.

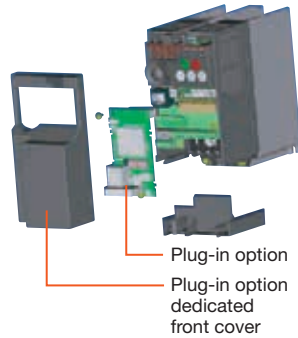

### Compact and space-saving

- The mounting dimensions are the same as the conventional FR-E500 model to keep backwards compatibility.
- Space can be saved with the side-by-side installation.



### Improved reliability and easy maintenance

- Spring clamp terminals provide high reliability and easy wiring. (FR-E700-SC/NF/NC)
- The inverter with the safety stop function can comply with the safety standards without incurring too much cost. (FR-E700-SC/NF/NC)
- Using the self-diagnosis function, the part life warning can be output and the degree of deterioration can be monitored to prevent malfunction.
- The removable control circuit terminal block simplifies replacement work.

### Environmentally friendly

- Filter options reduce the electromagnetic noise generated at the inverter and enables compliance with the harmonic suppression guidelines of Japan.

## Model

FR - E 7 2 0 - 3.7K

Symbol	Voltage class	Symbol	Number of phases	Symbol	Applicable motor capacity	Symbol	Control circuit terminal specification	Symbol	Function	Inverter model	Inverter capacity
2	200 V class	None	Three-phase input	0.1K to 15K	Represents the capacity (kW)	None	Standard control circuit terminal (screw type)	None	Standard type	FR-E720(SC)(NF)(NC)(-NE)(SC-TM)	0.1 kW to 15 kW
4	400 V class	S	Single-phase input			SC	Safety stop function model	-NE	Ethernet communication	FR-E740(SC)(NF)(NC)(-NE)(SC-TM)	0.4 kW to 15 kW
1	100 V class	W	Single-phase input (double-voltage output)			NF	FL remote communication model	-TM*	Dedicated EtherCAT communication model	FR-E720S(SC)*2	0.1 kW to 2.2 kW
						NC	CC-Link communication model			FR-E710W*2	0.1 kW to 0.75 kW

\*1: By installing the EtherCAT communication option (E7NECT\_2P manufactured by HMS Industrial Networks AB), EtherCAT communication is possible.  
\*2: The output of the single-phase 200 V and single-phase 100 V input models is three-phase 200 V.

## Specifications

Control method	Soft-PWM control, high carrier frequency PWM control (V/F control, General-purpose magnetic flux vector control, Advanced magnetic flux vector control or Optimum excitation control can be selected)
Starting torque	200%0.5 Hz (3.7K or lower) 150% 0.5 Hz (5.5K or higher) with Advanced magnetic flux vector control
Output frequency range	0.2 to 400 Hz
Regenerative braking torque*1	0.1K/0.2K.....150%, 0.4K/0.75K.....100%, 1.5K.....50%, 2.2K or higher.....20%
Acceleration/deceleration time setting	0 to 3600 s (up to two types of accelerations and decelerations can be set individually.)
Multi-speed	15 speeds
Speed command*2	0 to 5 VDC, 0 to 10 VDC, 4 to 20 mA, digital setting with setting dial, digital setting with operation panel or parameter unit
Safety stop*3	Output shutoff S1 and S2
Alarm output*4	1 changeover contact (230 VAC 0.3 A, 30 VDC 0.3 A), open collector output
Output signal*4	Two types of open collector outputs and one type of contact output (1 changeover contact) can be selected from inverter running, up to frequency, frequency detection, output current detection, operation ready, overload warning, fault output, and alarm, etc.
Monitor function	One monitored item can be selected from output frequency, motor current (steady or peak value), output voltage, frequency setting value, motor torque, converter output voltage, regenerative brake duty, and output power, etc. Pulse train output (1440 pulse/s, 1 mA)*5, analog output 0 to 10 VDC (when using optional analog terminal block), pulse output (when using optional pulse train terminal block)
Restart after instantaneous power failure	Available (frequency search method, reduced voltage method)
Removable terminal block	Used for control circuit terminals
Communication function	Communication supported as standard: RS-485 (Mitsubishi inverter protocol, MODBUS®RTU*6) or Ethernet*6. Communication supported when the compatible option is used: CC-Link, PROFIBUS-DP, DeviceNet™, or LonWorks®. The FL remote communication model and the CC-Link communication model are available.

\*1: Braking torque is the average short-time torque when a motor decelerates to a stop from 60 Hz in the shortest time. (It varies with the motor loss.) It is not a continuous regenerative torque. The average deceleration torque becomes lower when a motor decelerates from a frequency higher than the base frequency. The inverter is not equipped with a built-in brake resistor. Use an optional brake resistor for an operation with large regenerative power. (Not available for 0.1K and 0.2K.) Brake unit (FR-BU2) can be also used.  
\*2: For the FL remote communication model, commands can be input from the operation panel or through FL remote communication. For the CC-Link communication model, commands can be input from the operation panel or through CC-Link communication.

\*3: Not available for the standard model.

\*4: The FL remote communication model and the CC-Link communication model have only one open collector output terminal. (For the FL remote communication model, the terminal is fixed to output the safety monitor output signal (not selectable).)

\*5: Not available for the FL remote communication model and the CC-Link communication model.

\*6: Availability depends on the communication type of the inverter specifications.



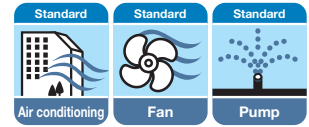

## Features

### ■ Suitable for both the general-purpose motor and the IPM motor

- This series can drive both a general-purpose motor and an IPM motor. Switching between the two motor controls is simple—just a single parameter setting. Initially, a general purpose motor could be used, then upgraded to an IPM motor without switching this inverter, leading to lower cost of equipment.

### ■ Environmentally friendly

- Power factor improving DC reactor, common mode choke (line noise filter), capacitive filter (radio noise filter) are all essential for air conditioning applications, and all of these are included in the Filterpack. The inverter with Filterpack (FR-F7□0PJ-□F) is also available.

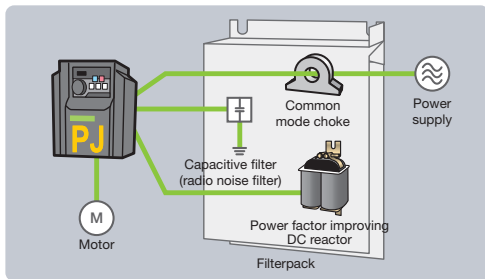

The inverter with Filterpack

- Less wiring and smaller space is required when Filterpack is used. Filterpack also enables compliance with the harmonic suppression guideline, the Architectural Standard Specifications (electrical installation), and the architectural standard specifications (machinery installation) in Japan.

### ■ Easy-to-use

- The following functions provide the ideal operation for fans and pumps (PID control, Optimum excitation control, regeneration avoidance, and automatic restart after instantaneous power failure).

### ■ Improved reliability and easy maintenance

- Spring clamp terminals provide high reliability and easy wiring.

## Model

FR - F 7 **4** 0 P J - **3.7K** □

Symbol	Voltage class
2	200 V class
4	400 V class

Symbol	Inverter capacity
0.4K to 15K	Represents the capacity (kW)

Symbol	Filterpack
None	Without
F	With*

Inverter model	Inverter capacity
FR-F720PJ	0.4 kW to 15 kW
FR-F740PJ	0.4 kW to 15 kW

#### <Precautions>

- Never drive an IPM motor in the IM drive setting.
- Use the same IPM motor capacity as the inverter capacity.
- For IPM motor, use an MM-EFS or MM-EF series motor. Please contact us regarding a combination with other manufacturer's IPM motor.

\*The inverter with Filterpack consists of an inverter and a Filterpack. The inverter carries the rating plate, "FR-F7□0PJ-□K," and the Filterpack carries the rating plate "FR-BFP2-□K."

## Specifications

Control method	Soft-PWM control, high carrier frequency PWM control (V/F control, General-purpose magnetic flux vector control, Optimum excitation control, and IPM motor control can be selected)	
Starting torque	General-purpose motor control	120% (at 1 Hz) with General-purpose magnetic flux vector control and slip compensation
	IPM motor control	50%
Output frequency range	0.2 to 400 Hz	
Regenerative braking torque	General-purpose motor control	15%*1
	IPM motor control	5% (10% for 1.5 kW or lower)*1
Acceleration/deceleration time setting	0.1 to 3600 s (up to two types of accelerations and decelerations can be set individually.)	
Multi-speed	15 speeds	
Speed command	0 to 5 VDC, 0 to 10 VDC, 4 to 20 mA, digital input with setting dial, digital setting with operation panel or parameter unit	
Alarm output	1 changeover contact (230 VAC 0.3 A, 30 VDC 0.3 A), open collector output	
Output signal	One type of open collector output and one type of contact output (1 changeover contact) can be selected from inverter running, up to frequency, frequency detection, output current detection, operation ready, overload warning, fault output, and alarm, etc.	
Monitor function	One monitored item can be selected from output frequency, motor current (steady or peak value), output voltage, frequency setting value, converter output voltage, regenerative brake duty, and output power, etc. Pulse train output (1440 pulses/s, 1 mA)	
Restart after instantaneous power failure	Available (frequency search method, reduced voltage method)	
Communication function	RS-485 supported (Mitsubishi inverter protocol and MODBUS®RTU) as standard	

\*1: Regenerative braking torque is the average short-time torque when a motor decelerates to a stop from the rated speed in the shortest time. (It varies with the motor loss.) It is not a continuous regenerative torque. The average deceleration torque becomes lower when a motor decelerates from a speed higher than the rated speed. When the regenerative power is large, use a braking option.

# Simple and compact inverter FR-D700 Series

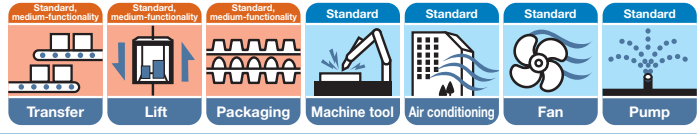

## Features

### ■ Improved reliability and easy maintenance

- Spring clamp terminals provide high reliability and easy wiring.
- Shutoff circuit (hardware) securely provides emergency output shutoffs.  
The inverter with the safety stop function can comply with the safety standards without incurring too much cost.
- Parameter writing/reading can be restricted with a 4-digit password.



### ■ Pursuing the best performance

- The General-purpose magnetic flux vector control and the auto tuning function enable reliable operation in applications that require large starting torque. (150% 1 Hz, 200% 3 Hz (3.7K or lower with the slip compensation))



### ■ Easy-to-use (pursuing the easy operation)

- The non-slip, adaptable scroll speed setting dial allows for quick jumps or precise increments based on turning speed.
- An enclosure surface operation panel, which can be attached on an enclosure surface, is available as an option.
- The inverters with 0.4K or higher capacity have built-in regenerative brake transistors, and their usage can be extended to a lift application.

### ■ Environmentally friendly

- Filter options reduce the electromagnetic noise generated at the inverter and enables the compliance with the harmonic suppression guidelines of Japan.

## Model

FR - D 7 4 0 - 0.4K

Symbol	Voltage class
1	100 V class
2	200 V class
4	400 V class

Symbol	Number of phases
None	Three-phase input
S	Single-phase input
W	Single-phase input (double-voltage output)

Symbol	Applicable motor capacity
0.1K to 15K	Represents the capacity (kW)

Inverter model	Inverter capacity
FR-D720	0.1 kW to 15 kW
FR-D740	0.4 kW to 15 kW
FR-D720S*	0.1 kW to 2.2 kW
FR-D710W*	0.1 kW to 0.75 kW

\*The output of the single-phase 200 V and single-phase 100 V input models is three-phase 200 V.

## Specifications

Control method	Soft-PWM control, high carrier frequency PWM control (V/F control, General-purpose magnetic flux vector control, Optimum excitation control can be selected)
Starting torque	150% 1 Hz, 200% 3 Hz (3.7K or lower) with General-purpose magnetic flux vector control and slip compensation
Output frequency range	0.2 to 400 Hz
Regenerative braking torque <sup>*1</sup>	0.1K/0.2K.....150%, 0.4K/0.75K.....100%, 1.5K.....50%, 2.2K or higher.....20%
Acceleration/deceleration time setting	0 to 3600 s (up to two types of accelerations and decelerations can be set individually.)
Multi-speed	15 speeds
Speed command	0 to 5 VDC, 0 to 10 VDC, 4 to 20 mA, digital input with setting dial, digital setting with operation panel or parameter unit
safety stop	Monitor output S0, output shutoff S1 and S2
Alarm output	1 changeover contact (230 VAC 0.3 A, 30 VDC 0.3 A), open collector output
Output signal	One type of open collector output and one type of contact output (1 changeover contact) can be selected from inverter running, up to frequency, frequency detection, output current detection, operation ready, overload warning, fault output, and alarm, etc.
Monitor function	One monitored item can be selected from output frequency, motor current (steady or peak value), output voltage, frequency setting value, converter output voltage, regenerative brake duty, and output power, etc. Pulse train output (1440 pulses/s, 1 mA)
Restart after instantaneous power failure	Available (frequency search method, reduced voltage method)
Communication function	RS-485 (Mitsubishi inverter protocol and MODBUS <sup>®</sup> RTU) supported as standard

<sup>\*1</sup>: Braking torque is the average short-time torque when a motor decelerates to a stop from 60 Hz in the shortest time. (It varies with the motor loss.) It is not a continuous regenerative torque. The average deceleration torque becomes lower when a motor decelerates from a frequency higher than the base frequency. The inverter is not equipped with a built-in brake resistor. Use an option brake resistor for an operation with large regenerative power. Brake unit (FR-BU2) can be also used.

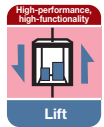

## Features

### Easy-to-use (Easy to design enclosure)

- The number of wires in the main circuit has been reduced to approx. 40% and the installation area has been reduced to approx. 60% (for 7.5K) compared to the conventional configuration with stand-alone common converters. Use this model to save the wiring and the space.
- For easy replacement, the installation size is the same as the conventional model (FR-A201).
- The braking circuit is built-in for this inverter, so the selection procedure for a braking option is no longer required.
- The total cost is reduced compared to the conventional system (inverter + power regenerative converter + AC reactor). Less heat is generated in this inverter because the regenerative power is returned to the power supply, leading to energy savings.

### Pursuing the best performance

- The power regeneration function enables excellent braking capacity (regenerative braking torque: 100% for continuous operation, 150% for 60 seconds).

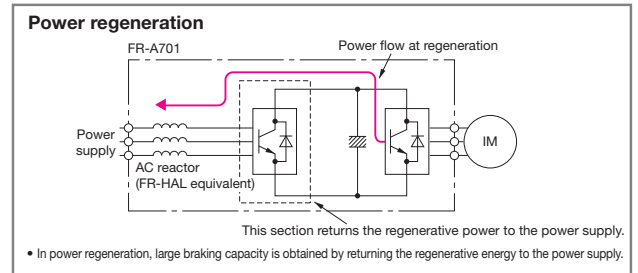
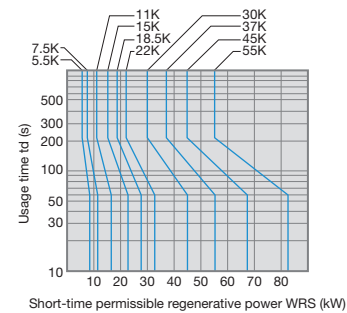

## Model

FR - **A721** - **5.5K**

Symbol	Voltage class	Symbol	Applicable motor capacity
A721	200 V class	5.5K to 55K	Represents the capacity (kW).
A741	400 V class		

Applicable motor (kW)	5.5	7.5	11	15	18.5	22	30	37	45	55
Three-phase 200 V class FR-A721-□□	●	●	●	●	●	●	●	●	●	●
Three-phase 400 V class FR-A741-□□	●	●	●	●	●	●	●	●	●	●

● : Available

## Specifications

Control method	Soft-PWM control, high carrier frequency PWM control (V/F control, Advanced magnetic flux vector control, Real sensorless vector control, Vector control*1 or PM sensorless vector control can be selected)
Starting torque	150% 0.3 Hz with Real sensorless vector control or vector control*1
Output frequency range	0.2 to 400 Hz (Up to 120 Hz with Real sensorless vector control or vector control*1)
Regenerative braking torque	100% continuous 150% 60 s
Acceleration/deceleration time setting	0 to 3600 s (up to three types of accelerations and decelerations can be set individually.)
Multi-speed	15 speeds
Speed command	0 to 5 VDC, 0 to 10 VDC, 0 to ±5 VDC, 0 to ±10 VDC, 4 to 20 mA, digitally set with pulse train input, operation panel or parameter unit, 4-digit BCD or 16-bit binary (when using optional FR-A7AX)
Alarm output	1 changeover contact (230 VAC, 0.3 A, 30 VDC, 0.3 A), open collector output, alarm code (4-bit) output
Output signal	Five types of open collector outputs and two types of contact output (1 changeover contact) can be selected from inverter running, up to frequency, instantaneous power failure (undervoltage), frequency detection, operation ready, overload warning, error output and alarm, etc.
Monitor function	One type can be selected from output frequency, motor current, output voltage, operation speed, motor torque, converter output voltage (steady or peak value), input power, output power and load meter, etc. Pulse train output (1440 pulses/s, 2 mA) and analog output (0 to 10 VDC)
Restart after instantaneous power failure	Available (frequency search method, reduced voltage method)
Removable terminal block	Used for control circuit terminals
Communication function	Communication supported as standard: RS-485 (Mitsubishi inverter protocol, MODBUS®RTU). Communication supported when the compatible option is used: CC-Link, CC-Link IE Field Network, PROFIBUS-DP, DeviceNet™, LonWorks®, or SSCNET III communication.

\*1: Available when an option (FR-A7AP/FR-A7AL) is mounted.

# FR-CC2 Series

## Features

- For the 800 series large-capacity inverters (FR-A800: 315K or higher, FR-F800: 355K or higher), converter section (FR-CC2) and the inverter section are separated. This can contribute to space and cost savings of large capacity systems (except when one converter unit is connected to one inverter). The converter unit can be run with 12-phase rectifier power supply.

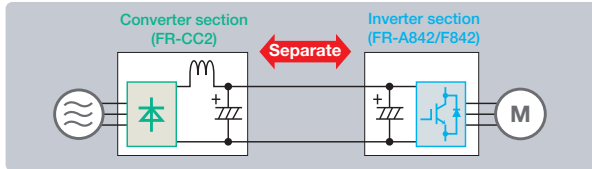

## Model

- Select the capacity of the converter unit according to the motor capacity.
- The converter unit has a built-in DC reactor.

FR-CC2-H 355K-60 P

Model	315K	355K	400K	450K	500K	560K	630K
FR-CC2-H□	●	●	●	●	●	●	●
FR-CC2-H□-P	—	—	●	●	●	●	—
FR-CC2-N□	—	—	—	—	—	—	—
FR-CC2-N□-P	—	—	—	—	—	—	—

● : Available — : Not available

Symbol	Voltage class	Symbol	Description	Symbol	Circuit board coating (IEC60721-3-3: 1994 3C2/3S2 compatible)	Plated conductor	Symbol	Function
H	400 V class	315K to 630K	Applicable motor capacity (kW)	60	With	Without	None	Standard type
N	690 V class			06	With	With	P	Parallel operation

## Inverter for pressure-resistant explosion-proof type motor

### FR-B Series (A800 specification)

\*As the inverter does not have an explosion proof structure, install it in a non-hazardous place.



- This inverter for pressure-resistant explosion-proof type motor, in combination with the Mitsubishi Electric pressure-resistant explosion-proof type motor, has passed the explosion-proof test by the Japanese Ministry of Health, Labour and Welfare.
- Always install the inverter away from the explosive environment.
- For the applicable options, refer to the Technical News (MF-X-052, MF-X-053, and MF-X-179).

#### FR-B

Applicable motor output [kW]	Variable torque type	
	200 V class	400 V class
0.2	FR-B-750	FR-B-750
0.4		
0.75		
1.5	FR-B-1500	FR-B-1500
2.2	FR-B-2200	FR-B-2200
3.7	FR-B-3700	FR-B-3700
5.5	FR-B-5.5K	FR-B-7.5K
7.5	FR-B-7.5K	
11	FR-B-11K	
15	FR-B-15K	FR-B-15K
22	FR-B-22K	FR-B-22K
30	FR-B-30K	FR-B-37K
37	FR-B-37K	
45	FR-B-45K	FR-B-55K
55	FR-B-55K	
75	FR-B-75K	FR-B-75K
90	—	FR-B-90K
110	—	FR-B-110K

#### FR-B3

Applicable motor output [kW]	Constant torque type	
	200 V class	400 V class
0.4	FR-B3-400	FR-B3-H400
0.75	FR-B3-750	FR-B3-H750
1.5	FR-B3-1500	FR-B3-H1500
2.2	FR-B3-2200	FR-B3-H2200
3.7	FR-B3-3700	FR-B3-H3700
5.5	FR-B3-5.5K	FR-B3-H5.5K
7.5	FR-B3-7.5K	FR-B3-H7.5K
11	FR-B3-11K	FR-B3-H11K
15	FR-B3-15K	FR-B3-H15K
18.5	FR-B3-18.5K	FR-B3-H18.5K
22	FR-B3-22K	FR-B3-H22K
30	FR-B3-30K	FR-B3-H30K
37	FR-B3-37K	FR-B3-H37K

#### FR-B4

Motor model	Inverter model
XE-VNJ 1.5kW	FR-B4(D)-1.5K
XE-VNJ 2.2kW	FR-B4(D)-2.2K
XE-VJ 3.7kW	FR-B4(D)-3.7K
XE-VJ 5.5kW	FR-B4(D)-5.5K
XE-VJ 7.5kW	FR-B4(D)-7.5K
XE-VJ 11kW	FR-B4(D)-11K
XE-VJ 18.5kW	FR-B4(D)-18.5K



### Main differences between the explosion-proof inverter and the standard inverter

Specifications	FR-B (FR-A800 specification)	FR-B3-N (FR-A800 specification)	FR-A800
Power supply voltage	200 V class 200 V 50 Hz, 200/220 V 60 Hz 400 V class 400 V 50 Hz, 400/440 V 60 Hz	200 V 50 Hz, 200/220 V 60 Hz 400 V 50 Hz, 400/440 V 60 Hz	200 to 240 V 50/60 Hz 380 to 500 V 50/60 Hz
Maximum output frequency	Limited to the maximum operating frequency of the motor	Limited to the maximum operating frequency of the motor	590 Hz
V/F control	Available	Not available	Available
Advanced magnetic flux vector control	Not available	Available	Available
Real sensorless vector control	Not available	Not available	Available
Vector control	Not available	Not available	Available
PM motor control	Not available	Not available	Available
Energy saving control selection	Not available	Not available	Available
PWM frequency	200 V class 55K or lower: 1 kHz 200 V class 75K: 2 kHz All the 400 V class capacities: 1 kHz (It is allowed to change the setting of Pr.72 PWM frequency selection.)	FR-B3: 2 kHz FR-B3-N: 14.5 kHz (low noise) (It is not allowed to change the setting of Pr.72 PWM frequency selection.)	2 kHz (initial value) (It is allowed to change the setting of Pr.72 PWM frequency selection.)

### Main differences between the FR-B4 series inverter and the FR-A800-R2R series inverter

This product is our pressure-resistant, explosion-proof, and vector motor driving inverter with the FR-A800-R2R (Roll to Roll dedicated model) specifications. Differences with the FR-A800-R2R are as follows.

Specifications	FR-B4	FR-B4D	FR-A800-R2R
AC power input (200 V class)	200 V 50 Hz 200/220 V 60 Hz	—	200 to 240 V AC 50/60 Hz
DC power input (200 V class)	—	283 to 375 VDC	283 to 339 VDC
Maximum output frequency	Limited to the maximum operating frequency of the motor		590Hz
V/F control	Not available		Available
Advanced magnetic flux vector control	Not available		Available
Real sensorless vector control	Not available		Available
Vector control	Available		Available
Energy saving control selection	Not available		Available
Parameter initial setting	Setting for the FR-B4(D).		Setting for the FR-A800-R2R.
Parameter setting restriction	Yes		No
Number of available plug-in option connectors	1 (Connector 1)		3

# Option Series

## Option lineup

A wide variety of options which improve function and performance, such as installation attachments, are available for the FR series lineup.

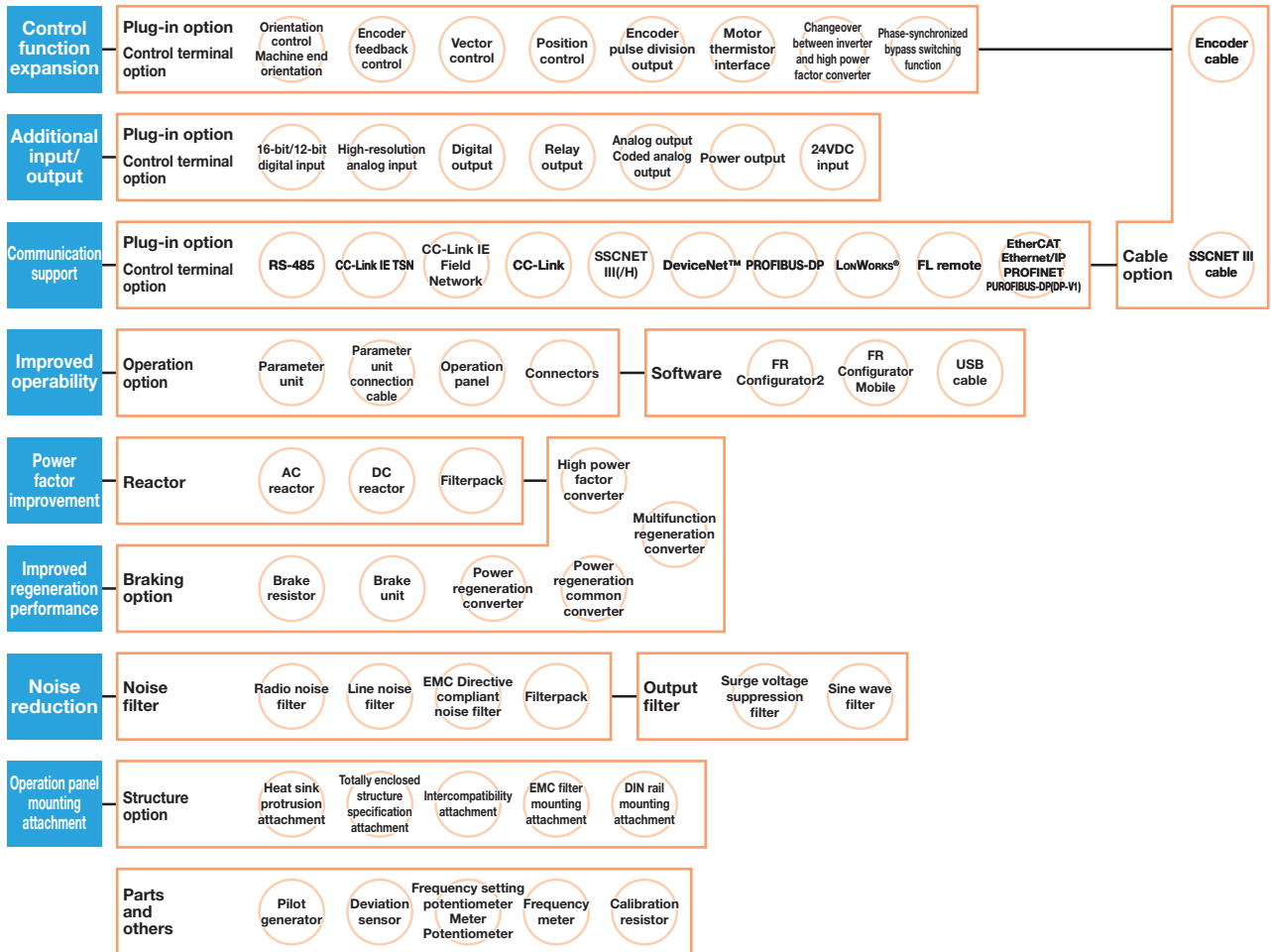

## Option connections

The main option connections are shown below.

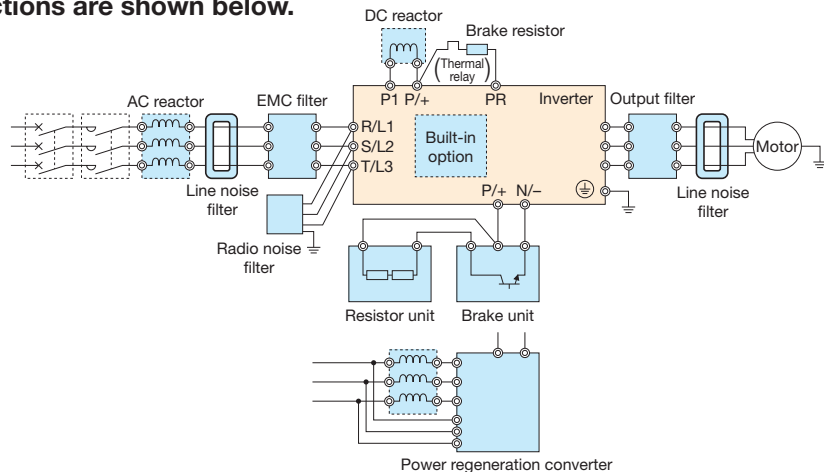

# List of options

○: Compatible X: Incompatible

Name	Model	Applicable inverter							
		FR-A800	FR-A800 Plus	FR-F800	FR-E800	FR-E700	FR-F700PJ	FR-D700	FR-A701
<b>Plug-in option (control function expansion, additional input/output)</b>									
Orientation control	FR-A8AP	○	○	×	○ (E kit type)	×	×	×	×
	FR-A8APR	○	○	×	×	×	×	×	×
Encoder feedback control	FR-A8APS	○	○	×	×	×	×	×	×
Vector control	FR-A7AP	×	×	×	×	×	×	×	○
	FR-A8AL	○	○	×	×	×	×	×	×
Orientation control	FR-A7AL	×	×	×	×	×	×	×	○
Encoder feedback control		×	×	×	×	×	×	×	○
Vector control		×	×	×	×	×	×	×	○
Position control		×	×	×	×	×	×	×	○
Encoder pulse division output	FR-A8APA	○	○*	×	×	×	×	×	×
Orientation control, Encoder feedback control, Vector control	FR-A8APD*	○	○*	×	×	×	×	×	×
Encoder pulse divider		○	○	○	○ (E kit type)	×	×	×	×
16-bit digital input	FR-A8AX	○	○	○	○ (E kit type)	×	×	×	×
	FR-A7AX	×	×	×	×	○ (E kit type)	×	×	○
Analog output (2 terminals)	FR-A8AY	○	○	○	○ (E kit type)	×	×	×	×
Digital output (7 terminals)	FR-A7AY	×	×	×	×	○ (E kit type)	×	×	○
Relay output (3 terminals)	FR-A8AR	○	○	○	○ (E kit type)	×	×	×	×
	FR-A7AR	×	×	×	×	○ (E kit type)	×	×	○
Coded analog output	FR-A8AZ	○	○	×	×	×	×	×	×
High-resolution analog input	FR-A7AZ	×	×	×	×	×	×	×	○
Motor thermistor interface		×	×	×	×	×	×	×	○
24 VDC input	FR-E7DS	×	×	×	×	○ (for the FR-E700-SC only)	×	×	×
Changeover between inverter and high power factor converter	FR-A8AVP	○**	○***	×	×	×	×	×	×
	Phase-synchronized bypass switching	○	○*	○	×	×	×	×	×
<b>Plug-in option (for communication)</b>									
RS-485	PU connector (inverter)	Equipped as standard	Equipped as standard	Equipped as standard	FR-E800	Equipped as standard <sup>1)</sup>	Equipped as standard	Equipped as standard	Equipped as standard
	Dedicated terminal (inverter)	Equipped as standard <sup>2)</sup>	Equipped as standard <sup>2)</sup>	Equipped as standard <sup>2)</sup>	×	FR-E7TR	×	×	Equipped as standard
USB	USB host	A connector	Equipped as standard	Equipped as standard	Equipped as standard	×	×	×	×
		B connector	×	×	×	×	×	×	Equipped as standard
	USB device	Mini B connector	Equipped as standard	Equipped as standard	Equipped as standard	Equipped as standard	Equipped as standard	×	×
CC-Link IE TSN	FR-A8NCG	○	○*	○	×	×	×	×	×
	Built-in	FR-A800-GN	×	×	FR-E800-E (EPA/EPB)	×	×	×	×
CC-Link IE Field Network	FR-A8NCE	○**	○	○	×	×	×	×	×
	FR-A7NCE	×	×	×	×	×	×	×	×
	Built-in	FR-A800-GF	×	×	×	×	×	×	○
CC-Link	FR-A8NC	○**	○	○	○ (E kit type)	×	×	×	×
	FR-A7NC	×	×	×	×	○ (E kit type)	×	×	×
SSCNET III(H)	FR-A8NS	○**	○	○	×	×	×	×	×
	Built-in	FR-A7NS	×	×	×	×	×	×	○
SSCNET III	FR-A7NS	×	×	×	×	×	×	×	○
	FR-A8ND	○**	○	○	○ (E kit type)	×	×	×	×
DeviceNet™	FR-A7ND	×	×	×	×	○ (E kit type)	×	×	○
	FR-A8NP	○**	○	○	○ (E kit type)	×	×	×	×
PROFIBUS-DP	FR-A7NP	×	×	×	×	○ (E kit type)	×	×	○
	FR-A8NL	×	×	○	×	×	×	×	×
LonWorks®	FR-A7NL	×	×	×	×	○ (E kit type)	×	×	○
	FR-A8NF	○**	○**	○	×	×	×	×	×
FL remote	FR-A7NF	×	×	×	×	×	×	×	×
	Built-in	×	×	×	×	FR-E700-NF	×	×	×
EtherCAT	A8NECT_2P (HMS Industrial Networks AB) <sup>1)</sup>	○	○	○	×	×	×	×	×
	E7NECT_2P (HMS Industrial Networks AB) <sup>1)</sup>	×	×	×	×	FR-E700-TM only	×	×	×
	Built-in	×	×	×	FR-E800-E (EPC)	×	×	×	×
EtherNet/IP	A8NEIP_2P (HMS Industrial Networks AB) <sup>1)</sup>	○	○	○	×	×	×	×	×
	Built-in	×	×	×	FR-E800-E (EPA)	×	×	×	×
PROFINET	A8NPRT_2P (HMS Industrial Networks AB) <sup>1)</sup>	○	○	○	×	×	×	×	×
	Built-in	×	×	×	FR-E800-E (EPB)	×	×	×	×
PROFIBUS-DP(DP-V1)	A8NDPV1 (HMS Industrial Networks AB) <sup>1)</sup>	○	○	○	×	×	×	×	
<b>Control terminal option</b>									
Vector control terminal block	FR-A8TP	○	○	×	×	×	×	×	×
Screw terminal block	FR-A8TR	○**	○**	○**	×	×	×	×	×
12 V control circuit terminal block with encoder power supply	FR-A7PS	×	×	×	×	×	×	×	○
RS-485 2-port terminal block	FR-E7TR	×	×	×	×	○ (for models with the standard control circuit terminal specification only)	×	×	×
<b>Dedicated cable option</b>									
Encoder cable	FR-V7CBL[ ]	○	○	×	○	×	×	×	○
	FR-JCBL[ ]	○	○	×	○	×	×	×	○
SSCNET III cable	MR-JBUS[ ]M- ]	×	×	×	×	×	×	○	
<b>Operation option</b>									
LCD operation panel	FR-LU08	○	○	○	FR-E800	×	×	×	×
Parameter unit	FR-PU07	○	○	○	FR-E800	○**	○	○	○
	FR-PU07BB	○	○	○	FR-E800	○**	×	×	×
Enclosure surface operation panel	FR-PA07	×	×	×	FR-E800	○	○	○	×
Parameter unit connection cable	FR-CB20[ ]	○	○	○	FR-E800	○	○	○	○
Operation panel connection connector	FR-ADP	○	○	○	○	×	×	×	○
<b>Software</b>									
FR Configurator2	SW1DND-FRC2	○	○	○	○	○	×	×	×
	FR-SW3-SETUP-WE	×	×	×	×	○**	○	○	○
FR Configurator Mobile	-	FR-A800-E	FR-A800-E	FR-F800-E	FR-E800-E/SCE	×	×	×	×
USB cable	MR-J3USBCBL3M	○	○	○	○	○	×	×	×
<b>Reactor</b>									
AC reactor	FR-HAL	○	○	○	○	○	○	○	×
DC reactor	FR-HEL	○	○	○	○	○	○	○	×

○: Compatible x: Incompatible

Name	Model	Applicable inverter							
		FR-A800	FR-A800 Plus	FR-F800	FR-E800	FR-E700	FR-F700PJ	FR-D700	FR-A701
<b>Braking option</b>									
Brake resistor	MRS, MYS	x	x	x	○ <sup>*10</sup>	○ <sup>*10</sup>	○ <sup>*10</sup>	○ <sup>*10</sup>	x
High-duty brake resistor	FR-ABR	○ <sup>*10</sup>	○ <sup>*10</sup>	x	○ <sup>*10</sup>	○ <sup>*10</sup>	○ <sup>*10</sup>	○ <sup>*10</sup>	x
Brake unit	FR-BU2	○ <sup>*11</sup>	○ <sup>*11</sup>	○ <sup>*11</sup>	○ <sup>*11</sup>	○ <sup>*11</sup>	○ <sup>*11</sup>	○ <sup>*11</sup>	x
Resistor	GRZG	○	○	○	○	○	○	○	x
	FR-BR	○	○	○	○	○	○	○	x
Resistor unit	MT-BR5	○	○	○	x	x	x	x	x
	FR-RC	○	○	○	x	x	x	x	x
Power regeneration converter	FR-HC2	○	○	○	○	○	○	○	x
High power factor converter	FR-XC	○	○	○	○	○	○	○	x
Multifunction regeneration converter	FR-XC	○	○	○	○	○	○	○	x
<b>Noise filter</b>									
Line noise filter	FR-BSF01	○ <sup>*12</sup>	○ <sup>*12</sup>	○ <sup>*12</sup>	○	○	○	○	○
	FR-BLF	○ <sup>*12</sup>	○ <sup>*12</sup>	○ <sup>*12</sup>	○	○	○	○	○
Radio noise filter	FR-BIF	Corresponding filter is built-in	Corresponding filter is built-in	Corresponding filter is built-in	○	○	○	○	○
EMC Directive compliant EMC filter	Built-in filter	Standard equipped (2nd Environment) <sup>*13</sup>			x	x	x	x	x
	SF□□	x	x	x	○	○	x	○	○
	FR-E5NF	x	x	x	○	○	○	○	x
Filterpack (DC reactor/noise filter)	FR-S5NFSA	x	x	x	○	○	x	○	x
	FR-BFP2	x	x	x	○	○	○ <sup>*14</sup>	○	x
<b>Output filter</b>									
Surge voltage suppression filter	FR-ASF	○ <sup>*15</sup>	○ <sup>*15</sup>	○ <sup>*15</sup>	○ <sup>*15</sup>	○	○ <sup>*15</sup>	○	○ <sup>*15</sup>
	FR-BMF	○ <sup>*15</sup>	○ <sup>*15</sup>	○ <sup>*15</sup>	○ <sup>*15</sup>	○	○ <sup>*15</sup>	○	○ <sup>*15</sup>
Sine wave filter	Reactor	MT-BSL(-HC)	○ <sup>*17</sup>	○ <sup>*17</sup>	○ <sup>*17</sup>	x	x	x	x
	Capacitor	MT-BSC	○ <sup>*17</sup>	○ <sup>*17</sup>	○ <sup>*17</sup>	x	x	x	x
<b>Structure option</b>									
Panel through attachment	FR-A8CN	○	○	○	x	x	x	x	x
	FR-E7CN	x	x	x	○	○	○	○	x
	FR-E8CN	x	x	x	○	x	x	x	x
Totally-enclosed structure attachment	FR-E7CV	x	x	x	x	○ <sup>*16</sup>	x	x	x
Control circuit terminal block	FR-A8TAT	○	○	○	x	x	x	x	x
Intercompatibility attachment	FR-AAT	○	○	○	○	○	○	○	x
	FR-A5AT	○	○	○	○	○	○	○	x
	FR-E7AT	x	x	x	○	○	x	x	x
	FR-F8AT	x	x	○	x	x	x	x	x
	FR-EBAT	x	x	x	○	x	x	x	x
EMC filter installation attachment	FR-E5T	x	x	x	○	○	○	○	x
DIN rail installation attachment	FR-UDA	x	x	x	○ <sup>*19</sup>	○ <sup>*19</sup>	○ <sup>*19</sup>	○ <sup>*19</sup>	x
<b>Other options</b>									
Pilot generator	QVAH-10	○	○	○	○	○	○	○	○
Deviation sensor	YVGC-500W-NS	○	○	○	○	○	○	○	○
Analog frequency meter	YM-206NRI 1 mA	○	○	○	FR-E800	○	○	○	○
Calibration resistor	RV24YN 10 kΩ	○	○	○	○	○	○	○	○

\*1: The option is not compatible with the FR-A800-R2R and FR-A800-AWH.  
\*2: The option is not compatible with the FR-A800-R2R.  
\*3: This product cannot be used on its own. Use it with the FR-A8AP or the FR-A8APA.  
\*4: The option is compatible with the FR-A842-315K to 500K.  
\*5: The option is not compatible with the FR-A800-E or FR-F800-E.  
\*6: PU connector is disabled for the FL remote communication model and the CC-Link communication model.  
\*7: The option is not compatible with the FR-A800-GF.  
\*8: For further details on supported models, contact your sales representative.  
\*9: FR Configurator is not compatible with FL remote communication models.  
\*10: Only models with a built-in brake transistor can be used.  
\*11: For the 200 V class 0.2K or lower, 400 V class 1.5K or lower, they cannot be used in combination with a brake unit.  
\*12: For the 55K or lower, a corresponding appliance is built-in on the input side.  
\*13: The applicable standard depends on the built-in EMC filter.  
\*14: Filterpack (FR-BFP2) is enclosed for the FR-F7[0PJ-]K inverters.  
\*15: The filter can be used under V/F control or Advanced magnetic flux vector control.  
\*16: The filter cannot be used during IPM motor control.  
\*17: The filter can be used under V/F control.  
\*18: The option is compatible with the FR-E720-0.1K to 7.5K only.  
\*19: The option is compatible with the models with the 3.7kW or lower capacity.

# Power regeneration converter selection chart

## Power regeneration contributing to energy saving and compact design offering power supply harmonic suppression

The optimal option can be selected according to the application.

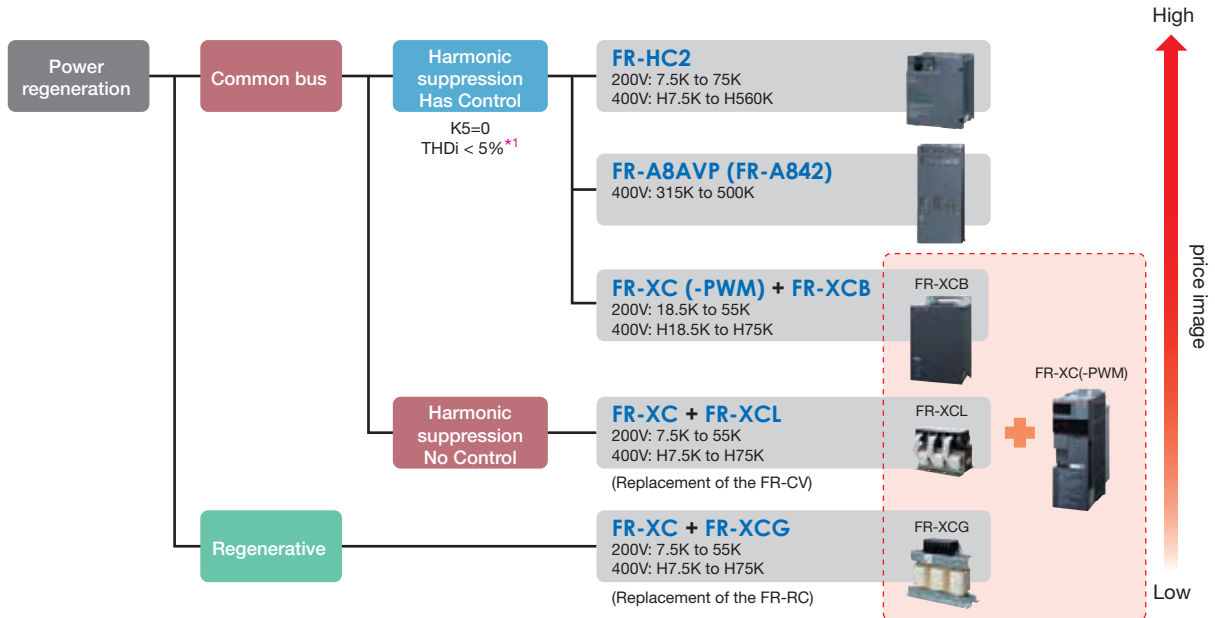

\*1: Measured at power supply input terminals of the FR-HCL21 (for FR-HC2), FR-A8BL1 (for FR-A8AVP), and FR-XCB (for FR-XC(-PWM) and FR-XCB) under nominal conditions. When the input voltage is distorted, harmonic contents increase because power harmonics flow into the high power factor converter or multifunction regeneration converter.

### Common bus regeneration

By connecting multiple inverters to a common converter, the power returned from an inverter during regenerative drive can be supplied to another inverter, which in turn saves energy. None of the inverters requires a brake unit, which enables total space and cost reduction.

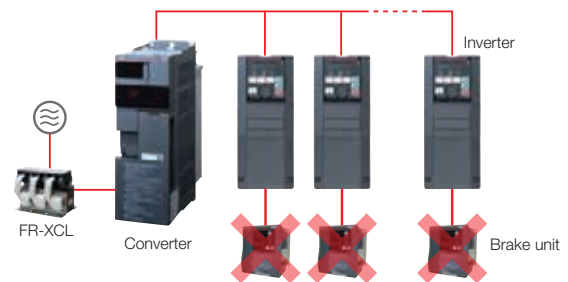

### Power regeneration

A power regeneration converter allows energy generated at braking operation of the inverter to be regenerated to the power supply. The capacity of the converter is selectable according to the regenerative power of the system. Thus, the compact converter is applicable for the regenerative power smaller than the inverter capacity, which contributes to space saving.

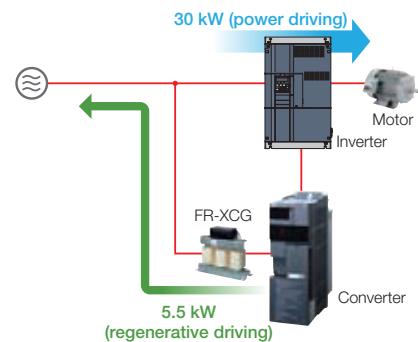

### Harmonic suppression

A converter with harmonic suppression function is classified as a self-excitation three-phase bridge circuit under the "Harmonic Suppression Guidelines for Specific Consumers" and achieves K5 = 0 (conversion factor for equivalent capacity). The waveform with high peaks, which is typical of the input current to the inverter section from the converter section in an inverter unit, is rounded to make a sine wave with a lower input current effective value. The total harmonic distortion of the input current (THDi) is 5% or less, which facilitates compliance with the overseas standards related to harmonic suppression.

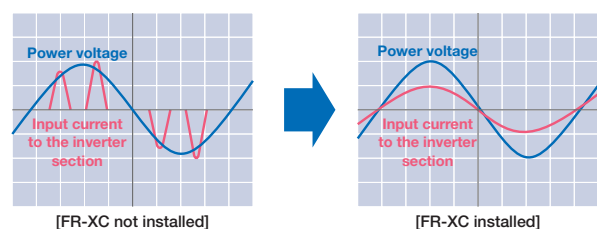



## Multifunction regeneration converter FR-XC

- One inverter can handle harmonic suppression and power regeneration.
- Functions that match the application can be selected by combining the inverter/converter with the dedicated reactor FR-XCB (box type) or FR-XCL/FR-XCG.

Combination matrix of FR-XCL/FR-XCG and FR-XC(-PWM)

Dedicated standalone reactor	Multifunction regeneration converter	
	FR-XC-[ ]	FR-XC-[ ]-PWM <sup>①</sup>
FR-XCL-[ ] FR-XCG-[ ]		
7.5K	7.5K	—
11K	11K	—
15K	15K	—
22K	22K	18.5K
30K	30K	22K
37K	37K	37K
55K	55K	55K
H7.5K	H7.5K	—
H11K	H11K	—
H15K	H15K	—
H22K	H22K	H18.5K
H30K	H30K	H22K
H37K	H37K	H37K
H55K	H55K	H55K
H75K	50°C rating H75K	50°C rating H75K
H90K	40°C rating H75K	40°C rating H75K

<sup>①</sup>: The harmonic suppression function is pre-enabled in this model. To use the converter with the FR-XCL, change the "9999" setting of Pr.416 Control method selection to "0" (harmonic suppression disabled).

Combination matrix of FR-XCB and FR-XC(-PWM)

Dedicated box-type reactor	Multifunction regeneration converter	
	FR-XC-[ ] <sup>②</sup>	FR-XC-[ ]-PWM
FR-XCB-[ ]		
18.5K	22K	18.5K
22K	30K	22K
37K	37K	37K
55K	55K	55K
H18.5K	H22K	H18.5K
H22K	H30K	H22K
H37K	H37K	H37K
H55K	H55K	H55K
H75K	H75K	H75K

<sup>②</sup>: The harmonic suppression function is not pre-enabled in this model. To use the converter with the FR-XCB, change the "9999" setting of Pr.416 Control method selection to "1" (harmonic suppression enabled).

Combination matrix of FR-MCB and FR-XC

Dedicated contactor box <sup>③</sup>	Multifunction regeneration converter
FR-MCB-H[ ]	FR-XC-[ ] (-PWM)
150	H75K

<sup>③</sup>: A dedicated contactor box used for coordination with the charging circuit.

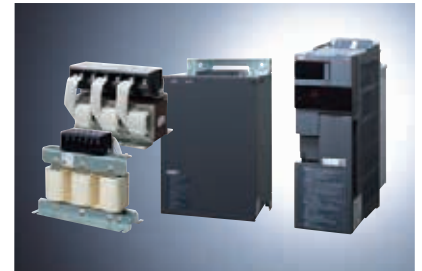

Combination matrix of FR-XCCP and FR-XC(-PWM)

Converter installation attachment for enclosure	Multifunction regeneration converter
FR-XCCP[ ]	FR-XC-[ ] <sup>④</sup>
01	(H)7.5K, (H)11K
02	(H)15K
03	(H)22K, (H)30K (H)18.5K-PWM, (H)22K-PWM

Combination matrix of FR-XCCU and FR-XC(-PWM)

IP20 compatible attachment	Multifunction regeneration converter
FR-XCCU[ ]	FR-XC-[ ] (-PWM) <sup>④</sup>
01	37K, H55K
02	55K
03	H37K

<sup>④</sup>: The capacities not listed in the tables are not available.

## Changeover between inverter and high power factor converter

# FR-A8AVP, FR-A8VPB-H, FR-A8BL1, FR-A8BL2, FR-A8BC, FR-A8MC

Install the plug-in option FR-A8AVP on a separated converter type inverter (FR-A842-315K to 500K) and set parameters. The inverter will be converted into a high power factor converter.

The following options are needed to use the converter: phase detection transformer box, dedicated filter reactor, dedicated reactor for PWM control, dedicated filter capacitor, inrush current limit resistor. The converter can be changed back to an inverter.

### Option lineup for the converter

Component model	Name
Plug-in	FR-A8AVP Phase detection option
Stand-alone	FR-A8VPB-H Phase detection transformer box
	FR-A8BL1-H[ ] Dedicated filter reactor
	FR-A8BL2-H[ ] Dedicated reactor for PWM control
	FR-A8BC-H[ ] Dedicated filter capacitor
	FR-A8MC-H[ ] Dedicated circuit parts for inrush current protection <sup>①</sup>

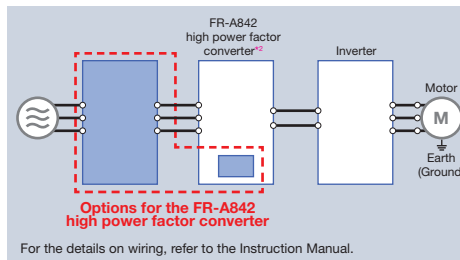

<sup>①</sup>: Including an inrush current limit resistor, MC power supply stepdown transformer, inrush current limit MC, buffer relay, mini relay, etc.

<sup>②</sup>: FR-A842 inverter serving as a high power factor converter.

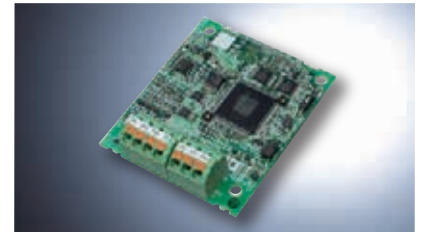

## High power factor converter FR-HC2

- Harmonic current is greatly suppressed, and the equivalent capacity conversion coefficient  $K5=0$  in the "Japanese specific consumer higher harmonics suppression guidelines" is achieved.
- Input current waveforms are improved to be sine waves.
- Power regeneration function is provided as standard.

Voltage class	High power factor converter	Voltage class	High power factor converter	Standard accessories
200 V class	FR-HC2-7.5K	400 V class	FR-HC2-H7.5K	Reactor 1, reactor 2, external box <sup>*</sup> (Use in combination with the above accessories. The wires for connecting the standard accessories are not included.)
	FR-HC2-15K		FR-HC2-H15K	
	FR-HC2-30K		FR-HC2-H30K	
	FR-HC2-55K		FR-HC2-H55K	
	FR-HC2-75K		FR-HC2-H75K	
			FR-HC2-H110K	
			FR-HC2-H160K	
			FR-HC2-H20K	
			FR-HC2-H280K	
			FR-HC2-H400K	
			FR-HC2-H560K	

<sup>\*</sup> Peripheral devices are separately provided for FR-HC2-H280K to H560K (not provided in a box).



## Brake unit FR-BU2

- The regenerative power from the motor is consumed as heat to improve the braking capacity of the motor.
- Connect this unit to the DC bus voltage directly to use with the conventional inverter.
- This unit can replace conventional models, BU, FR-BU, and MT-BU5.
- The units can be connected in parallel to handle large capacity.

Voltage class	Brake unit model	Voltage class	Brake unit model
200 V class*	FR-BU2-1.5K	400 V class*	FR-BU2-H7.5K
	FR-BU2-3.7K		FR-BU2-H15K
	FR-BU2-7.5K		FR-BU2-H30K
	FR-BU2-15K		FR-BU2-H55K
	FR-BU2-30K		FR-BU2-H75K
FR-BU2-55K	FR-BU2-H220K		
	FR-BU2-H280K		

\* Resistors and resistor units are required. Refer to the Instruction Manual for the combination patterns.



# Mitsubishi Electric Product Guide

Premium high-efficiency IPM motor

## MM-EFS/MM-THE4 Series

Compatible inverter  
FR-F800  
FR-F700PJ

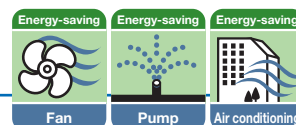

### Features

#### Energy savings with IPM motor

##### High efficiency achieved with IPM motors

- The IPM motors that have permanent magnets embedded in their rotors are even more efficient than the high-performance energy-saving motors.

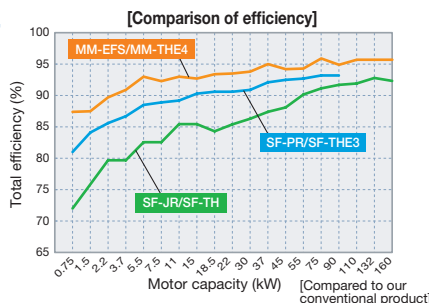

#### IE4-equivalent efficiency level

- A premium high-efficiency IPM motor "MM-EFS series/MM-THE4 series" provides even better efficiency that is equivalent to IE4 (super premium efficiency), the highest efficiency class\*.

\*As of June 2016

IEC 60034-30 Efficiency class	Efficiency of Mitsubishi Electric motors	
	General-purpose motor	IPM motor
IE4 (super premium efficiency)*1	—	Premium high-efficiency IPM (MM-EFS/MM-THE4)
IE3 (premium efficiency)	Super line premium series (SF-PR, SF-THE3)	—
IE2 (high efficiency)	High-performance energy-saving motor (SF-HR)	—
IE1 (standard efficiency)	Standard three-phase motor (SF-JR)	—
Below the class	—	—

\*1: The details of IE4 can be found in IEC 60034-31.

#### Smooth replacement from a general-purpose motor (with the same installation size)

- The frame number is the same (same size) as the Mitsubishi Electric general-purpose motors (4-pole SF-JR/SF-HR series). Replacement is easy as the installation sizes are compatible. (55kW or lower)

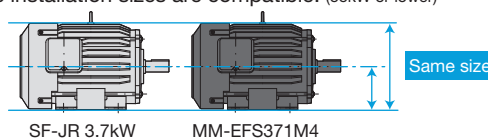

#### Improved lifespan and reliability

- Bearing grease lasts longer than that of general-purpose motors. Design life: Approx. 7 years (60000 hours)
- The motor is equipped with anti-creep bearings as standard. Slip does not occur with synchronous motor, and precise operation is achievable.
- Magnetic pole positions are detected automatically. The motor does not use a magnetic position sensor consisting of electric devices, and that ensures high reliability.

### Model

[ 55 kW or lower ]

MM - EFS 7 1M 4 -S10

Symbol	Output	Symbol	Voltage class	Symbol	Specifications <sup>②</sup>	Symbol	Specifications <sup>②</sup>
See motor models in table below	See rated output in table below	None	200 V	None	Standard model	None	Standard model
		4	400 V	Q	Class B	P1	Outdoor type
		Symbol	Rated speed <sup>①</sup>	Symbol	Dedicated specification		
		1M	1500 r/min	None	Standard model		
		3	3000 r/min	-S10	Belt drive model		

\*1: It can be also used for an application with the rated speed 1800 r/min.  
\*2: The outdoor type and class B are semi-standard models.

[ 75 kW or higher ]

MM - T H E 4

- The motor can be used for applications which required the rated speed of 1500 r/min and 1800 r/min.
- For dedicated motors such as the outdoor type, the long-axis type, the flange type, the waterproof outdoor type, and the corrosion proof type, contact your sales representative.

Rated output (kW)	0.75	1.5	2.2	3.7	5.5	7.5	11	15	18.5	22	30	37	45	55	75	90	110	132	160
Motor model name	7	15	22	37	55	75	11K	15K	18K	22K	30K	37K	45K	55K	—	—	—	—	—
200 V class	MM-EFS□1M	●	●	●	●	●	●	●	●	●	●	●	●	●	—	—	—	—	—
	MM-EFS□1M-S10	—	—	—	—	—	—	—	—	—	—	—	—	—	—	—	—	—	—
	MM-EFS□3	●	●	●	●	●	●	●	●	—	—	—	—	—	—	—	—	—	—
400 V class	MM-EFS□1M4	●	●	●	●	●	●	●	●	●	●	●	●	●	—	—	—	—	—
	MM-EFS□1M4-S10	—	—	—	—	—	—	—	—	—	—	—	—	—	—	—	—	—	—
	MM-EFS□34	●	●	●	●	●	●	●	●	—	—	—	—	—	—	—	—	—	—
200 V class	MM-THE4	—	—	—	—	—	—	—	—	—	—	—	—	—	—	—	—	—	—
400 V class	MM-THE4	—	—	—	—	—	—	—	—	—	—	—	—	—	●	●	●	●	●

#### Caution

- The IPM motor MM-EFS/MM-THE4 series cannot be driven by the commercial power supply.
- The total wiring length for an IPM motor should be 100 m or less.
- Only one IPM motor can be connected to each inverter.
- For belt drive application of the 11 kW or higher MM-EFS series IPM motor with the 1500 r/min specification, use a dedicated belt drive motor. The 11 kW or higher motors with 3000 r/min specification are designed for a direct connection only.

● : Available — : Not available

MM-EFS 1500 r/min

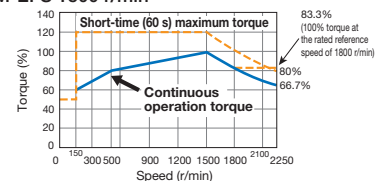

MM-EFS 3000 r/min

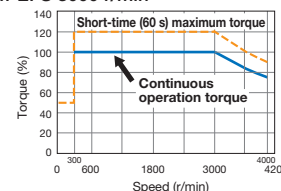

# SF-V5RU

- When the motor is driven by the inverter supporting Vector control\*1, continuous operation at 100% torque is enabled over the speed range from 1500 r/min to as low as 0 r/min.
- An encoder and cooling fan are built-in.
- In addition to the standard type with legs, the flange type and type with brakes can be manufactured.
- It is suitable for winder and unwinder applications. Motors with speed ratio of 1000/2000 r/min, 1000/3000 r/min and 500/2000 r/min specifications are available and they can support applications whose winding diameter greatly changes.



\*1: Vector control is available for the inverter to which a Vector control compatible option is installed:  
FR-A800 with FR-A8AP/FR-A8AL/FR-A8TP, FR-E800 with FR-A8AP E kit, or FR-A701 with FR-A7AP

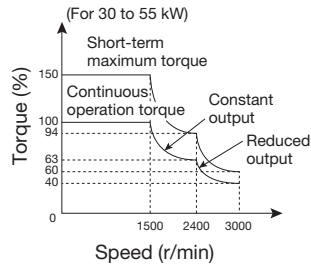
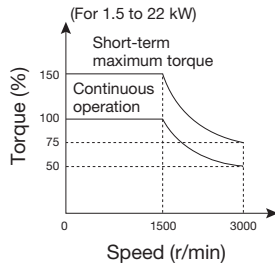

\*The maximum speed for the 55 kW is 2400 r/min.

# WS-V Series

"WS-V Series" is the new circuit breakers that have a lot of superior aspects such as higher breaking capacity, design for easy use, standardization of accessory parts, and compliance to the global standards.



## Features

### ■ A 54-mm-wide body, which belongs to the smallest class in the industry

The compact body allows for downsizing of the equipment and enclosure.

The breakers have been downsized to 54 mm wide and 52 mm depth (decreased by 16 mm compared with S-class general-purpose products).

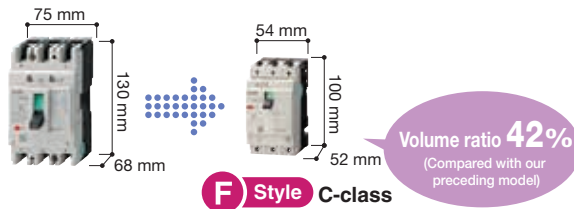

When multiple units are used, the width becomes significantly smaller.

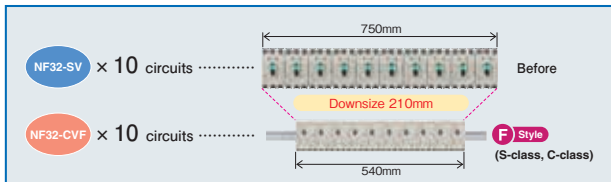

### ■ Conforms to various global standards

- New JIS standard: JIS C 8201-2-1(NF), JIS C 8201-2-2(NV) Annex 1 and Annex 2
- Electrical Appliances and Materials Safety Act (PSE)
- IEC standard: IEC 60947-2
- EN (Europe): EN 60947-2, CE marking (TÜV certification, self declaration)
- GB standard (China): GB/T 14048.2 CCC certification
- Safety certification (Korea): KC marking

### ■ Three-phase power supply supported by CE/CCC marked earth leakage circuit breakers

GB/T 14048.2-2008 was established in China, requiring the earth leakage circuit breaker to fulfill its function even if a phase is lost as is the case with the EN standard in Europe. CE/CCC marked earth leakage circuit breakers of the WS-V series support three phase power supply. Compliance with the revised standard is certified.

### ■ Lineup of UL 489 listed circuit breakers with 54 mm width "Small Fit" **F Style**

The compact breakers contribute to a size reduction of machines, and IEC 35 mm rail mounting is standard.



For security and standard compliance of machines, F-type and V-type operating handles are available for breakers with 54 mm width.

### ■ Lineup of UL 489 listed circuit breakers for 480 V AC "High Performance"

The breaking capacity has been improved to satisfy the request for SCCR upgrading.

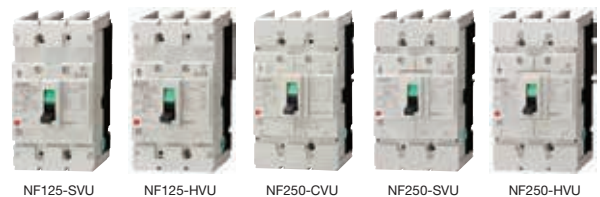

Breaking capacity of UL 489 listed circuit breakers for 480 V AC (UL 489) (Example of 240 V AC)

NF125-SVU/NV125-SVU	50 kA
NF125-HVU/NV125-HVU	100 kA
NF250-CVU/NV250-CVU	35 kA
NF250-SVU/NV250-SVU	65 kA
NF250-HVU/NV250-HVU	100 kA

# MS-T Series

Mitsubishi Electric magnetic motor starters have been newly designed and the MS-T series has been released! The MS-T series is smaller than ever, enabling more compact control panel. The MS-T series is suitable for other Mitsubishi Electric FA equipment. In addition, the MS-T conforms to a variety of global standards, supporting the global use.







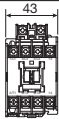

## Features

### Compact

General-purpose magnetic contactor with smallest width\*1 in the industry. The width of MS-T series is reduced by 32% as compared to the prior MS-N series, enabling a more compact panel. To select the model, refer to the catalog of each inverter.

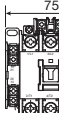
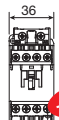
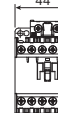
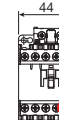
\*1: Based on Mitsubishi Electric research as of November 2020 in the general-purpose magnetic contactor industry for 10 A-frame class.

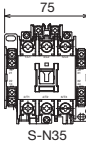
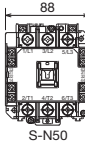
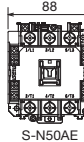
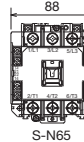
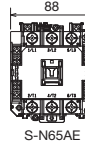
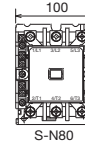
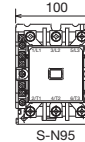
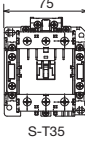
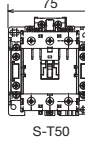

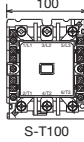
Frame size	11A	13A		20A	25A	32A	
MS-N series	 S-N10	 S-N11 (Auxiliary 1-pole)	 S-N12 (Auxiliary 2-pole)	 S-N20	 S-N25	None	
New MS-T series	 S-T10	 S-T12 (Auxiliary 2-pole)		 S-T20	 S-T25	 S-T32	
Frame size	35A	50A		65A	80A	100A	
MS-N series	 S-N35	 S-N50	 S-N50AE	 S-N65	 S-N65AE	 S-N80	 S-N95
New MS-T series	 S-T35	 S-T50		 S-T65	 S-T80	 S-T100	

### Standardization

Terminal covers are provided as standard to ensure safety inside the enclosure. Users do not have to make arrangements to specify and obtain options separately. Covers are provided also for the auxiliary contact unit. Users can reduce their inventory.

- Widened range of operation coil ratings (AC operated model)  
The widened range reduces the number of operation coil rating types from 13 (MS-N series) to 7.  
The reduced number of the operation coil types enables more simplified customers' ordering process and the faster delivery.
- Customers can select the operation coil more easily.

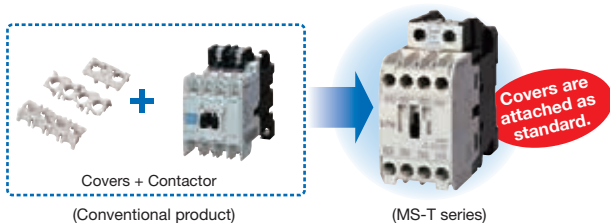

Coil designation	Rated voltage [V]	
	50 Hz	60 Hz
AC24V	24	24
AC48V	48 to 50	48 to 50
AC100V	100	100 to 110
AC120V	110 to 120	115 to 120
AC127V	125 to 127	127
AC200V	200	200 to 220
AC220V	208 to 220	220
AC230V	220 to 240	230 to 240
AC260V	240 to 260	260 to 280
AC380V	346 to 380	380
AC400V	380 to 415	400 to 440
AC440V	415 to 440	460 to 480
AC500V	500	500 to 550

Coil designation	Rated voltage [V]	
	50 Hz/60 Hz	
AC24V	24	
AC48V	48 to 50	
AC100V	100 to 127	
AC200V	200 to 240	
AC300V	260 to 300	
AC400V	380 to 440	
AC500V	460 to 550	

\*Seven types are available without change for the 50 A frame model or higher.

Integrated coil ratings facilitate selection!

### Global Standard

- Conforms to various global standards  
Our magnetic contactors are not only certified with major international standards such as IEC, JIS, UL, CE, and CCC but also ship classification standards and country specific standards too.

Standard	Applicable Standard				Safety Standard
	International	Japan	Europe		China
			EN EC Directive	Certification Body	
IEC *2	JIS	CE	TÜV Rheinland	CCC	UL US

\*2: Compliant with the requirements for mirror contacts in standards such as IEC 60947-4-1, and TÜV-certified.

■ Spring Clamp Terminal Models Available for Mitsubishi Electric Magnetic Contactor and Magnetic Relay

## Features

Key features of the screwless terminals.

■ **Significant reduction in the time required for wiring**

Comparison with the screw terminal model (with round crimp terminal)

Wiring with ferrules: 22% reduction

Wiring with solid or stranded wire: 52% reduction

Reduction in the time required for wiring

Wiring performed by non-experts (with 2-year experience)

(The research conducted by Japan Switchboard & control system Industries Association)

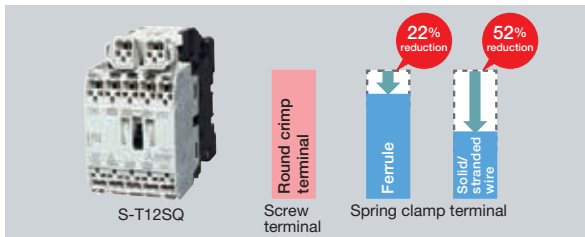

■ **Easy wiring for whoever works on**

Push-in connection eliminates the need for the screw-tightening skills.

■ **Enhanced maintenance efficiency**

Screw retightening is not necessary for installation and maintenance of enclosures and machines.

■ **Reliable wire connection**

There is no risk of terminal screw loosening due to vibration or shocks, or long-term service.

### Motor Circuit Breaker

## MMP-T Series

Motor circuit protection (against overload / phase loss / short-circuit) is achievable the MMP-T series alone. The wire-saving, space-saving design enables downsizing of the enclosure. The MMP-T series can be used in combination with the MS-T series (DC operated model).

## Features

■ **What is the motor circuit breaker?**

The motor circuit breaker, applicable to the motor circuit, has the functions of a circuit breaker and a thermal overload relay in one unit. The motor circuit breaker provides protection against overload, phase loss, and short circuit.

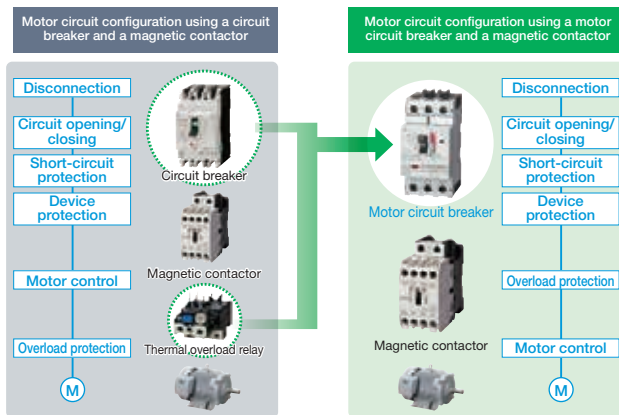

■ **Space-saving design for downsizing of the enclosure**

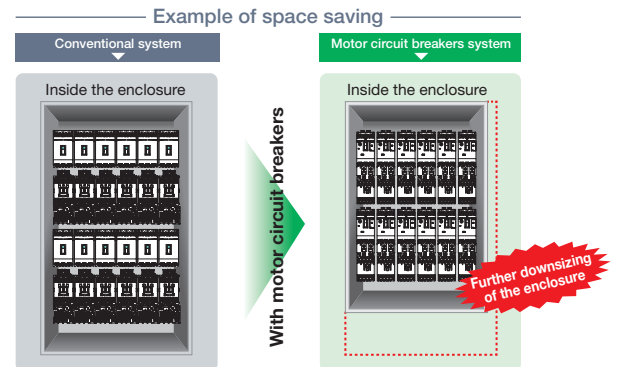

■ **Wire saving**

Using a connection conductor unit (option) for connecting a motor circuit breaker and a contactor reduces work hours required for wiring. A connection conductor unit for the high sensitivity contactor (SD-Q) is also available. (Model: UT-MQ12)

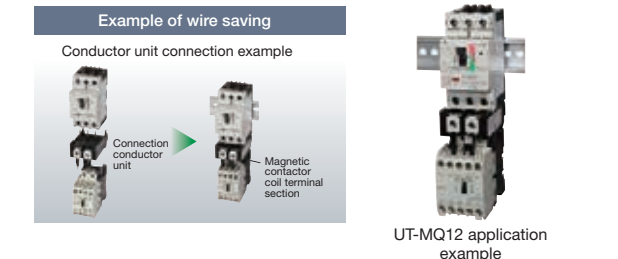

■ **Compliance to major standards support customers' overseas business**

- Compliance with major global standards  
Not only major international standards such as IEC, JIS, UL, CE, and CCC but also other national standards are certified. This will help our customers expand their business in foreign countries.
- Compliant with the requirements for mirror contacts in standards such as IEC 60947-4-1, and TÜV-certified.

Standard	Applicable standard				Safety Standard U.S.A./Canada
	International	Japan	Europe	China	
IEC	JIS	EN EC Directive CE	Certification body TÜV Rheinland	GB CCC	UL US

# EcoMonitorLight

The handy, low cost energy measuring module with an integrated display visualizes energy consumption.

## Features

### ■ Measurement and display of the energy consumption in a single module

With the built-in LCD display, the single module enables measurement and display of the energy consumption. The module can be used for simple measurement of the production equipment (motors, compressors, etc.) and verification of the energy saving effect by measuring the energy consumption before and after introduction of high-efficiency equipment (inverters, etc.).

### ■ System coordination facilitated by the standard MODBUS® RTU communication function

The MODBUS® RTU communication is supported as standard, facilitating coordination with the host system (programmable controller, GOT, etc.).

For example, by using GOT to visualize the energy consumption at work sites, you can raise the awareness of energy saving, and achieve the energy management in response to the actual operation of the production equipment.

\* The GOT sample screen data can be downloaded free of charge from the Mitsubishi Electric FA Global Website.

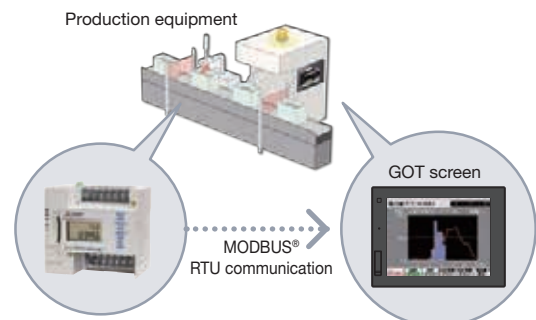

Energy measuring module in the enclosure  
Energy information is transmitted to GOT using MODBUS® RTU communication.





## Molded case circuit breaker, magnetic contactor, cable gauge (FR-A800)

### •280K or lower

Voltage	Motor output (kW) <sup>①</sup>	Applicable inverter model (ND rating)	Molded case circuit breaker (MCCB) <sup>②</sup> or earth leakage circuit breaker (ELB) (NF, NV type)		Input side magnetic contactor <sup>③</sup>		Recommended Cable gauge (mm <sup>2</sup> ) <sup>④</sup>		U, V, W
			Power factor improving (AC or DC) reactor connection		Power factor improving (AC or DC) reactor connection		R/L1, S/L2, T/L3		
			Without	With	Without	With	Without	With	
200 V class	0.4	FR-A820-0.4K (00046)	5 A	5 A	S-T10	S-T10	2	2	2
	0.75	FR-A820-0.75K (00077)	10 A	10 A	S-T10	S-T10	2	2	2
	1.5	FR-A820-1.5K (00105)	15 A	15 A	S-T10	S-T10	2	2	2
	2.2	FR-A820-2.2K (00167)	20 A	15 A	S-T10	S-T10	2	2	2
	3.7	FR-A820-3.7K (00250)	30 A	30 A	S-T21	S-T10	3.5	3.5	3.5
	5.5	FR-A820-5.5K (00340)	50 A	40 A	S-T35	S-T21	5.5	5.5	5.5
	7.5	FR-A820-7.5K (00490)	60 A	50 A	S-T35	S-T35	14	14	8
	11	FR-A820-11K (00630)	75 A	75 A	S-T35	S-T35	14	14	14
	15	FR-A820-15K (00770)	125 A	100 A	S-T50	S-T50	22	22	22
	18.5	FR-A820-18.5K (00930)	150 A	125 A	S-T65	S-T50	38	22	22
	22	FR-A820-22K (01250)	175 A	125 A	S-T100	S-T65	38	38	38
	30	FR-A820-30K (01540)	225 A	150 A	S-T100	S-T100	60	60	60
	37	FR-A820-37K (01870)	250 A	200 A	S-N150	S-N125	80	60	60
	45	FR-A820-45K (02330)	300 A	225 A	S-N180	S-N150	100	100	100
	55	FR-A820-55K (03160)	400 A	300 A	S-N220	S-N180	100	100	100
	75	FR-A820-75K (03800)	—	400 A	—	S-N300	—	125	125
90	FR-A820-90K (04750)	—	400 A	—	S-N300	—	150	150	
400 V class	0.4	FR-A840-0.4K (00023)	5 A	5 A	S-T10	S-T10	2	2	2
	0.75	FR-A840-0.75K (00038)	5 A	5 A	S-T10	S-T10	2	2	2
	1.5	FR-A840-1.5K (00052)	10 A	10 A	S-T10	S-T10	2	2	2
	2.2	FR-A840-2.2K (00083)	10 A	10 A	S-T10	S-T10	2	2	2
	3.7	FR-A840-3.7K (00126)	20 A	15 A	S-T10	S-T10	2	2	2
	5.5	FR-A840-5.5K (00170)	30 A	20 A	S-T21	S-T12	2	2	2
	7.5	FR-A840-7.5K (00250)	30 A	30 A	S-T21	S-T21	3.5	3.5	3.5
	11	FR-A840-11K (00310)	50 A	40 A	S-T21	S-T21	5.5	5.5	5.5
	15	FR-A840-15K (00380)	60 A	50 A	S-T35	S-T21	8	5.5	5.5
	18.5	FR-A840-18.5K (00470)	75 A	60 A	S-T35	S-T35	14	8	8
	22	FR-A840-22K (00620)	100 A	75 A	S-T35	S-T35	14	14	14
	30	FR-A840-30K (00770)	125 A	100 A	S-T50	S-T50	22	22	22
	37	FR-A840-37K (00930)	150 A	100 A	S-T65	S-T50	22	22	22
	45	FR-A840-45K (01160)	175 A	125 A	S-T100	S-T65	38	38	38
	55	FR-A840-55K (01800)	200 A	150 A	S-T100	S-T100	60	60	60
	75	FR-A840-75K (02160)	—	200 A	—	S-T100	—	60	60
	90	FR-A840-90K (02600)	—	225 A	—	S-N150	—	60	60
	110	FR-A840-110K (03250)	—	225 A	—	S-N180	—	80	80
132	FR-A840-132K (03610)	—	350 A	—	S-N220	—	100	100	
150	FR-A840-160K (04320)	—	400 A	—	S-N300	—	125	125	
160	FR-A840-160K (04320)	—	400 A	—	S-N300	—	125	125	
185	FR-A840-185K (04810)	—	400 A	—	S-N300	—	150	150	
220	FR-A840-220K (05470)	—	500 A	—	S-N400	—	2×100	2×100	
250	FR-A840-250K (06100)	—	600 A	—	S-N600	—	2×100	2×100	
280	FR-A840-280K (06830)	—	600 A	—	S-N600	—	2×125	2×125	

\*1: Assumes the use of a Mitsubishi Electric 4-pole standard motor with the power supply of 200/400 VAC 50 Hz.

\*2: Select an MCCB according to the power supply capacity. Install one MCCB per inverter.

For the use in the United States or Canada, refer to "Instructions for UL and cUL" in the Instruction Manual (Startup) or Instruction Manual (Hardware), and select an appropriate fuse or molded case circuit breaker (MCCB).

\*3: The magnetic contactor is selected based on the AC-1 class. The electrical durability of magnetic contactor is 500,000 times. When the magnetic contactor is used for emergency stops during motor driving, the electrical durability is 25 times. If using an MC for emergency stop during motor driving or using it on the motor side during commercial power supply operation, select an MC with the class AC-3 rated current for the rated motor current.

\*4: Cables

For FR-A820-03160(55K) or lower and FR-A840-01800(55K) or lower, it is the gauge of a cable with the continuous maximum permissible temperature of 75°C. (HIV cable (600 V grade heat-resistant PVC insulated wire), etc.) It assumes a surrounding air temperature of 50°C or lower and the wiring distance of 20 m or shorter.

For FR-A820-03800(75K) or higher and FR-A840-02160(75K) or higher, it is the gauge of the cable with the continuous maximum permissible temperature of 90°C or higher. (LMFC (heat resistant flexible cross-linked polyethylene insulated cable), etc.) It assumes a surrounding air temperature of 50°C or lower and in-enclosure wiring.

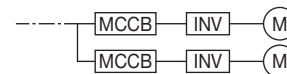

#### NOTE

- When the inverter capacity is larger than the motor capacity, select an MCCB and a magnetic contactor according to the inverter model, and select cables and reactors according to the motor output.
- When the breaker on the inverter's input side trips, check for the wiring fault (short circuit), damage to internal parts of the inverter etc. The cause of the trip must be identified and removed before turning ON the power of the breaker.

### •315K or higher

Voltage	Motor output (kW) <sup>①</sup>	Applicable inverter model (ND rating)	Applicable converter model	Molded case circuit breaker (MCCB) <sup>②</sup> or earth leakage circuit breaker (ELB) (NF, NV type)	Input-side magnetic contactor <sup>③</sup>	HIV cables, etc. (mm <sup>2</sup> ) <sup>④</sup>		
						R/L1, S/L2, T/L3	P/+, N/-	U, V, W
400 V class	315	FR-A842-315K (07700)	FR-CC2-H315K-60	700 A	S-N600	2 x 150	2 x 150	2 x 150
	355	FR-A842-355K (08660)	FR-CC2-H355K-60	800 A	S-N600	2 x 200	2 x 200	2 x 200
	400	FR-A842-400K (09620)	FR-CC2-H400K-60	900 A	S-N800	2 x 200	2 x 200	2 x 200
	450	FR-A842-450K (10940)	FR-CC2-H450K-60	1000 A	1000 A rated product	2 x 250	2 x 250	2 x 250
	500	FR-A842-500K (12120)	FR-CC2-H500K-60	1200 A	1000 A rated product	3 x 200	3 x 200	2 x 250

\*1: Assumes the use of a Mitsubishi Electric 4-pole standard motor with the motor capacity of 400 VAC 50 Hz.

\*2: Select an MCCB according to the power supply capacity. Install one MCCB per converter.

For the use in the United States or Canada, refer to "Instructions for UL and cUL" in the Instruction Manual (Startup) or Instruction Manual (Hardware), and select an appropriate fuse or molded case circuit breaker (MCCB).

\*3: The magnetic contactor is selected based on the AC-1 class. The electrical durability of magnetic contactor is 500,000 times. When the magnetic contactor is used for emergency stops during motor driving, the electrical durability is 25 times.

If using an MC for emergency stop during driving the motor, select an MC regarding the converter unit input side current as JEM1038-AC-3 class rated current. When using an MC on the inverter output side for commercial-power supply operation switching using a general-purpose motor, select an MC regarding the rated motor current as JEM1038-AC-3 class rated current.

\*4: The gauge of the cable with the continuous maximum permissible temperature of 90°C or higher. (LMFC (heat resistant flexible cross-linked polyethylene insulated cable), etc.). It assumes a surrounding air temperature of 40°C or lower and in-enclosure wiring.

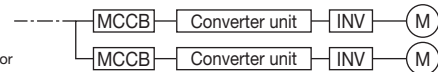

#### NOTE

- When the converter unit capacity is larger than the motor capacity, select an MCCB and a magnetic contactor according to the converter unit model, and select cables and reactors according to the motor output.
- When the breaker on the converter unit's input side trips, check for the wiring fault (short circuit), damage to internal parts of the inverter and the converter unit, etc. The cause of the trip must be identified and removed before turning ON the power of the breaker.

For the other series, refer to the catalog of each series.

## List of Alternative Models for the Conventional Series

Conventional series name	Production termination schedule	Repairs and spare parts available until <sup>*1</sup>	Alternative model
FR-F2	December 1986	November 1993	FR-F800 FR-A800 <sup>*2</sup>
FR-K	December 1986	November 1993	FR-A800
FR-K400	July 1989	June 1996	FR-A800
FR-F300	July 1989	June 1996	FR-F800 FR-A800 <sup>*2</sup>
FR-K3	July 1989	June 1996	FR-A800
FR-E	September 1993	August 2000	FR-A800
FR-Z020	March 1994	March 2001	FR-E800 FR-D700
FR-Z300	June 1994	June 2001	FR-A800
FR-Z100	December 1994	December 2001	FR-A800
FR-Z123	March 1995	March 2002	FR-E800 FR-D700
FR-F400	June 1995	June 2002	FR-F800 FR-A800 <sup>*2</sup>
FR-A200	October 1995	October 2002	FR-A800
FR-Z024	October 1995	October 2002	FR-E800 FR-D700
FR-V200	April 1996	April 2003	FR-A800 + FR-A8AP/FR-A8AL/FR-A8TP
FR-A100	April 1996	April 2003	FR-F800
FR-Z200	June 1996	April 2003	FR-A800
FR-A200E	April 2000	April 2007	FR-A800
MT-A100E	April 2000	April 2007	FR-F800
FR-A100E	September 2000	September 2007	FR-F800
MT-A200E	September 2000	September 2007	FR-A800
FR-U100	September 2001	September 2008	FR-D700
FR-S500 (Three-phase 200 V)	June 2004	June 2011	FR-D700
FR-V200E	October 2004	October 2011	FR-A800 + FR-A8AP/FR-A8AL/FR-A8TP
FR-S500 (Three-phase 400 V/single-phase 200V/ single-phase 100 V)	May 2006	May 2013	FR-D700
FR-F500 (L)	May 2006	May 2013	FR-F800
FR-A500 (L)	April 2007	April 2014	FR-A800
FR-A024/A044	December 2008	December 2015	FR-E800 FR-D700
FR-A201E	September 2009	September 2016	FR-A701
FR-S500E	August 2010	August 2017	FR-D700
FR-E500	April 2011	April 2018	FR-E800
FR-F700	August 2011	August 2018	FR-F800
FR-FP700	August 2011	August 2018	FR-F800
FR-HC (200 V)	October 2011	October 2018	FR-HC2 (200 V)
MT-HC (200 V)	October 2011	October 2018	FR-HC2 (200 V)
MT-B	November 2011	November 2018	FR-B
FR-F500J	April 2012	April 2019	FR-F700PJ
FR-FP500J	April 2012	April 2019	FR-F700PJ
FR-C500	April 2012	April 2019	FR-E800 + FR-A8NC E kit
FR-HC (400 V)	October 2012	October 2019	FR-HC2 (400 V)
MT-HC (400 V)	October 2012	October 2019	FR-HC2 (400 V)
SC-A	April 2015	April 2022	FR-D700
MD-AX520	September 2015	September 2022	FR-A800
FR-A700	December 2015	December 2022	FR-A800
FR-F700P	September 2016	September 2023	FR-F800
FR-V500	January 2017	January 2024	FR-A800 + FR-A8TP
FR Configurator SW3	October 2017	—	FR Configurator2
FR-B/B3 (FR-A700 Specification)	December 2017	December 2024	FR-B/B3 (FR-A800 Specification)
FR Series manual controller/speed controller	April 2018	April 2025	FR-A800
FR-RC	October 2018	October 2025	FR-XC + FR-XCG
FR-CV	June 2019	June 2026	FR-XC + FR-XCL

\*1: Repairs are subject to the supply of spare parts and may not be possible even within the specified time period.

\*2: For the operation where the inverter output current exceeds 120% of its rated current, select the FR-A800 series.



# Warranty

When using this product, make sure to understand the warranty described below.

## Warranty period and coverage

We will repair any failure or defect (hereinafter referred to as "failure") in our FA equipment (hereinafter referred to as the "Product") arisen during warranty period at no charge due to causes for which we are responsible through the distributor from which you purchased the Product or our service provider. However, we will charge the actual cost of dispatching our engineer for an on-site repair work on request by customer in Japan or overseas countries. We are not responsible for any on-site readjustment and/or trial run that may be required after a defective unit are repaired or replaced.

### [Term]

The term of warranty for Product is twelve months after your purchase or delivery of the Product to a place designated by you or eighteen months from the date of manufacture whichever comes first ("Warranty Period"). Warranty period for repaired Product cannot exceed beyond the original warranty period before any repair work.

### [Limitations]

- (1) You are requested to conduct an initial failure diagnosis by yourself, as a general rule. It can also be carried out by us or our service company upon your request and the actual cost will be charged.  
However, it will not be charged if we are responsible for the cause of the failure.
- (2) This limited warranty applies only when the condition, method, environment, etc. of use are in compliance with the terms and conditions and instructions that are set forth in the instruction manual and user manual for the Product and the caution label affixed to the Product.
- (3) Even during the term of warranty, the repair cost will be charged on you in the following cases;
  - 1) a failure caused by your improper storing or handling, carelessness or negligence, etc., and a failure caused by your hardware or software problem
  - 2) a failure caused by any alteration, etc. to the Product made on your side without our approval
  - 3) a failure which may be regarded as avoidable, if your equipment in which the Product is incorporated is equipped with a safety device required by applicable laws and has any function or structure considered to be indispensable according to a common sense in the industry
  - 4) a failure which may be regarded as avoidable if consumable parts designated in the instruction manual, etc. are duly maintained and replaced
  - 5) any replacement of consumable parts (condenser, cooling fan, etc.)
  - 6) a failure caused by external factors such as inevitable accidents, including without limitation fire and abnormal fluctuation of voltage, and acts of God, including without limitation earthquake, lightning and natural disasters
  - 7) a failure generated by an unforeseeable cause with a scientific technology that was not available at the time of the shipment of the Product from our company
  - 8) any other failures which we are not responsible for or which you acknowledge we are not responsible for

## Term of warranty after the stop of production

- (1) We may accept the repair at charge for another seven (7) years after the production of the product is discontinued. The announcement of the stop of production for each model can be seen in our Sales and Service, etc.
- (2) Please note that the Product (including its spare parts) cannot be ordered after its stop of production.

## Service in overseas

Our regional FA Center in overseas countries will accept the repair work of the Product; however, the terms and conditions of the repair work may differ depending on each FA Center. Please ask your local FA center for details.

## Exclusion of responsibility for compensation against loss of opportunity, secondary loss, etc.

Regardless of the gratis warranty term, Mitsubishi Electric shall not be liable for compensation to:

- (1) Damages caused by any cause found not to be the responsibility of Mitsubishi Electric.
- (2) Loss in opportunity, lost profits incurred to the user by Failures of Mitsubishi Electric products.
- (3) Special damages and secondary damages whether foreseeable or not, compensation for accidents, and compensation for damages to products other than Mitsubishi Electric products.
- (4) Replacement by the user, maintenance of on-site equipment, start-up test run and other tasks.

## Change of Product specifications

Specifications listed in our catalogs, manuals or technical documents may be changed without notice.

## Application and use of the Product

- (1) For the use of our product, its applications should be those that may not result in a serious damage even if any failure or malfunction occurs in product, and a backup or fail-safe function should operate on an external system to product when any failure or malfunction occurs.
- (2) Our product is designed and manufactured as a general purpose product for use at general industries.  
Therefore, applications substantially influential on the public interest for such as atomic power plants and other power plants of electric power companies, and also which require a special quality assurance system, including applications for railway companies and government or public offices are not recommended, and we assume no responsibility for any failure caused by these applications when used.  
In addition, applications which may be substantially influential to human lives or properties for such as airlines, medical treatments, railway service, incineration and fuel systems, man-operated material handling equipment, entertainment machines, safety machines, etc. are not recommended, and we assume no responsibility for any failure caused by these applications when used.  
We will review the acceptability of the abovementioned applications, if you agree not to require a specific quality for a specific application. Please contact us for consultation.



# Mitsubishi Electric's global FA network delivers reliable technologies and security around the world.

■ Production base   
 ● Development center   
 ● Global FA Center   
 ▲ Mechatronics showroom   
 ● Mitsubishi Electric sales office

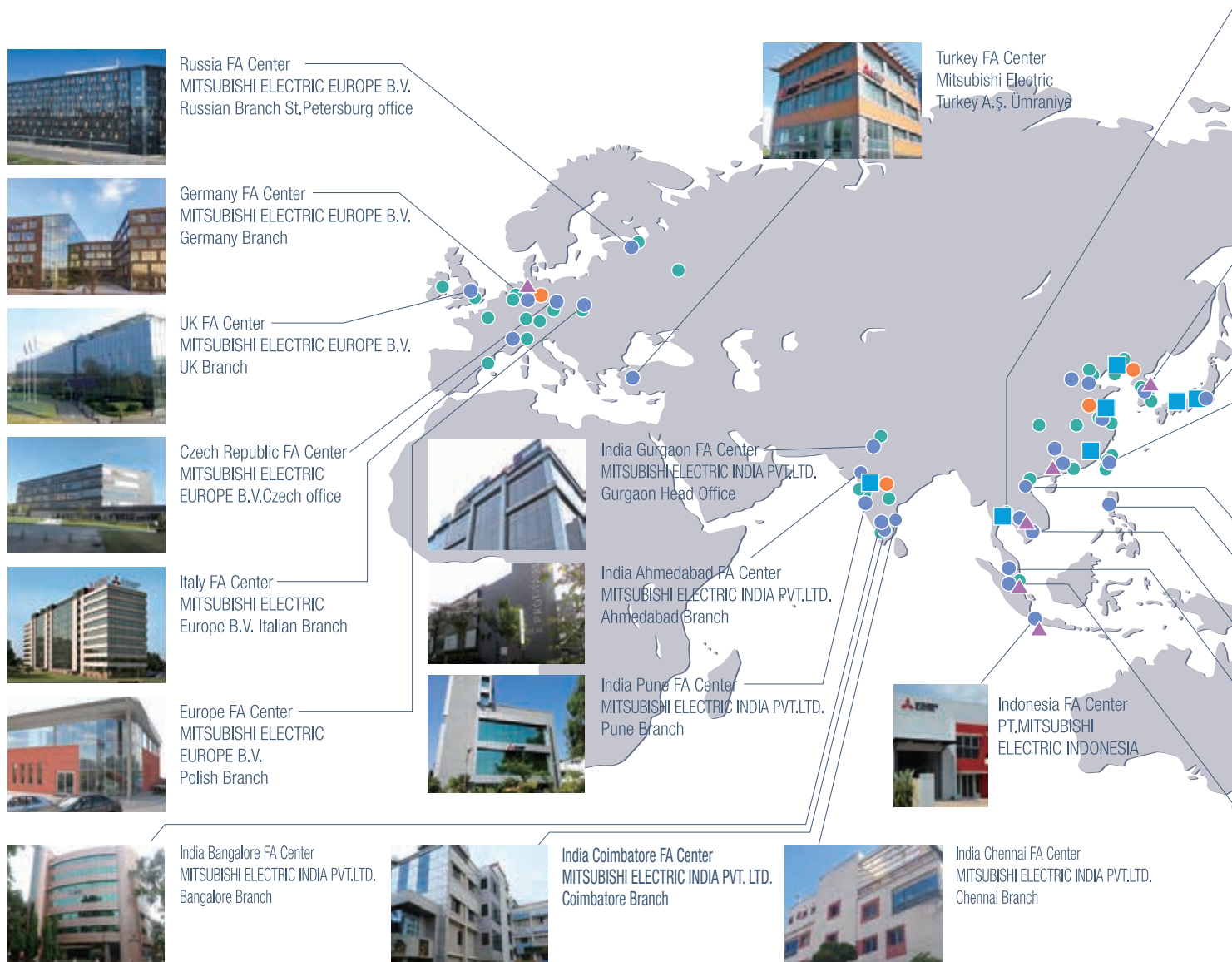

## Production bases Under the lead of Nagoya Works, we form a powerful network to optimize our manufacturing processes.

### Domestic bases

#### Nagoya Works



Shinshiro Factory  
Kani Factory

### Production bases overseas

#### MDI Mitsubishi Electric Dalian Industrial Products Co., Ltd.



MEAMC Mitsubishi Electric Automation Manufacturing (Changshu) Co., Ltd.

#### MEI Mitsubishi Electric India Pvt.



MEATH Mitsubishi Electric Automation (Thailand) Co., Ltd.



Thailand FA Center  
MITSUBISHI ELECTRIC FACTORY  
AUTOMATION(THAILAND) CO.,LTD

Korea FA Center  
MITSUBISHI ELECTRIC  
AUTOMATION KOREA CO.,LTD.

MITSUBISHI ELECTRIC CORPORATION  
Factory Automation Systems Group

Taichung FA Center  
MITSUBISHI ELECTRIC  
TAIWAN CO.,LTD

Taipei FA Center  
SETSUYO ENTERPRISE CO.,LTD

Philippines FA Center  
MELCO FACTORY AUTOMATION  
PHILIPPINES INC.

Malaysia FA Center

ASEAN FA Center  
MITSUBISHI ELECTRIC  
ASIA PTE.LTD.

Hanoi FA center  
Mitsubishi Electric  
Vietnam  
Company Limited  
Hanoi Branch

Ho Chi Minh FA Center  
MITSUBISHI ELECTRIC  
VIETNAM COMPANY  
LIMITED

North America FA Center  
MITSUBISHI ELECTRIC  
AUTOMATION,INC.

Mexico Monterrey FA Center  
Monterrey Office, Mitsubishi  
Electric Automation, Inc.

Mexico FA Center  
Querétaro Office, Mitsubishi  
Electric Automation, Inc.

Mexico City FA Center  
Mexico FA Center  
Mexico Branch, Mitsubishi  
Electric Automation, Inc.

Brazil FA Center  
Mitsubishi Electric do Brasil  
Comércio e Serviços Ltda.

Brazil Votorantim FA Center  
MELCO CNC do Brasil  
Comércio e Serviços S.A.

Service bases are established around the world to provide the same services as in Japan globally. Overseas bases are opening one after another to support our customers' business expansion.

Area	Our overseas	FA centers
EMEA	39	7
China	25	4
Asia	49	16
Americas	19	6
Total	132	33

-As of March 2021

## China

Beijing FA Center  
MITSUBISHI ELECTRIC  
AUTOMATION (CHINA)LTD.

Tianjin FA Center  
MITSUBISHI ELECTRIC  
AUTOMATION (CHINA)LTD.

Guangzhou FA Center  
MITSUBISHI ELECTRIC  
AUTOMATION (CHINA)LTD.

Shanghai FA Center  
MITSUBISHI ELECTRIC  
AUTOMATION (CHINA) LTD.

# This solution solves customers' issues and concerns by enabling visualization and analysis that lead to improvements and increase availability at production sites.

Utilizing our FA and IT technologies and collaborating with e-F@ctory Alliance partners, we reduce the total cost across the entire supply chain and engineering chain, and support the improvement initiatives and one-step-ahead manufacturing of our customers.



FA integrated solutions reduce total cost

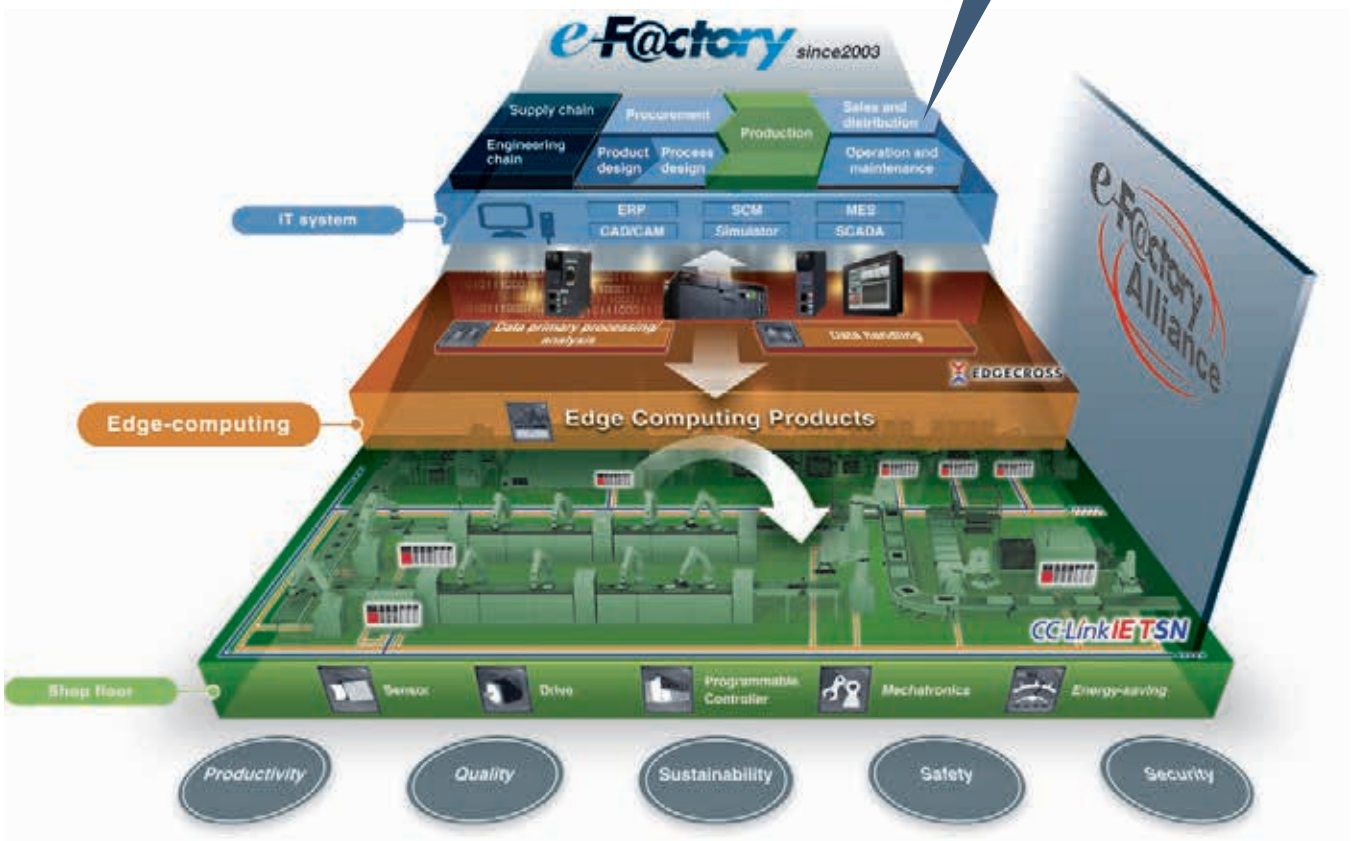
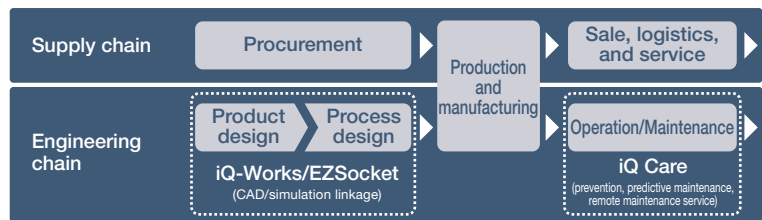

Overall production information is captured in addition to energy information, enabling the realization of efficient production and energy use (energy savings).

**•Trademarks**

PROFIBUS, PROFINET, and PROFIsafe are either trademarks or registered trademarks of PROFIBUS & PROFINET International. DeviceNet, EtherNet/IP, and CIP safety are either trademarks or registered trademarks of ODVA. EtherCAT is a trademark of Beckhoff Automation GmbH. Safety over EtherCAT is a trademark of Beckhoff Automation GmbH. MODBUS is a registered trademark of SCHNEIDER ELECTRIC USA, INC.

BACnet is a registered trademark of the American Society of Heating, Refrigerating and Air-Conditioning Engineers (ASHRAE). CC-Link IE TSN and CC-Link IE Field Network Basic are registered trademarks of CC-Link Partner Association. Other company and product names herein are the trademarks and registered trademarks of their respective owners.

**⚠ Safety Warning**

To ensure proper use of the products listed in this catalog, please be sure to read the instruction manual prior to use.

# YOUR SOLUTION PARTNER

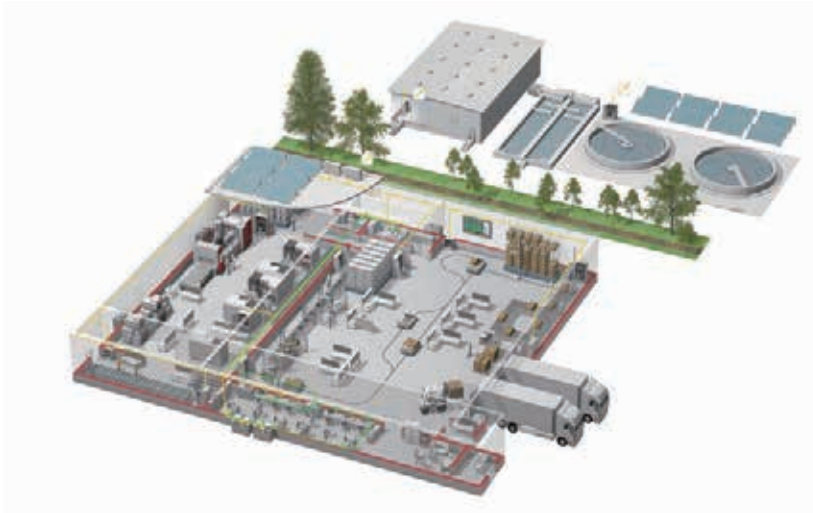

Mitsubishi Electric offers a wide range of automation equipment from PLCs and HMIs to CNC and EDM machines.

## A NAME TO TRUST

Since its beginnings in 1870, some 45 companies use the Mitsubishi name, covering a spectrum of finance, commerce and industry.

The Mitsubishi brand name is recognized around the world as a symbol of premium quality.

Mitsubishi Electric Corporation is active in space development, transportation, semi-conductors, energy systems, communications and information processing, audio visual equipment and home electronics, building and energy management and automation systems, and has 237 factories and laboratories worldwide in over 121 countries.

This is why you can rely on Mitsubishi Electric automation solution - because we know first hand about the need for reliable, efficient, easy-to-use automation and control in our own factories.

As one of the world's leading companies with a global turnover of over 4 trillion Yen (over \$40 billion), employing over 100,000 people, Mitsubishi Electric has the resource and the commitment to deliver the ultimate in service and support as well as the best products.



Low voltage: MCCB, MCB, ACB



Medium voltage: VCB, VCC



Power monitoring, energy management



Compact and Modular Controllers



Inverters, Servos and Motors



Visualisation: HMIs



Numerical Control (NC)



Robots: SCARA, Articulated arm



Processing machines: EDM, Lasers, IDS



Transformers, Air conditioning, Photovoltaic systems

\* Not all products are available in all countries.

Mitsubishi Electric Corporation Nagoya Works is a factory certified for ISO 14001 (standards for environmental management systems) and ISO 9001 (standards for quality assurance management systems).

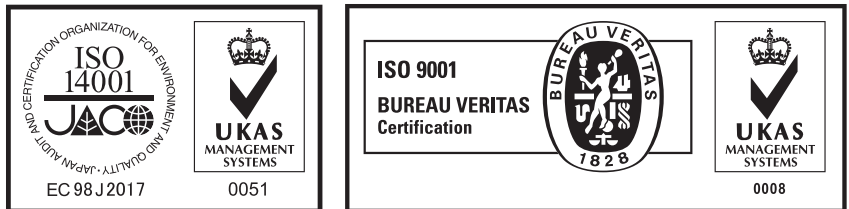

# MITSUBISHI ELECTRIC CORPORATION

HEAD OFFICE: TOKYO BLDG., 2-7-3, MARUNOUCHI, CHIYODA-KU, TOKYO 100-8310, JAPAN