

**FREQROL**

**The best choice for a complete range of applications.**

Energy savings (CO<sub>2</sub> reduction)

Machine tool

Amusement facility

Pump

Air conditioning

Transfer

Winding and unwinding

Lift

The advertisement features a central blue globe with the word 'FREQROL' in large white letters. Surrounding the globe are several rectangular images showing various industrial and commercial applications: a factory with smokestacks, a machine tool, an amusement park roller coaster, a fountain, a modern glass skyscraper, a conveyor belt system, a warehouse with high ceilings, and a person working in a factory setting. Small white arrows point from the globe to each of these images, with labels for each application: 'Energy savings (CO<sub>2</sub> reduction)', 'Machine tool', 'Amusement facility', 'Pump', 'Air conditioning', 'Transfer', 'Winding and unwinding', and 'Lift'. The central text reads 'The best choice for a complete range of applications.'

# 800/700 Series INVERTER



800/700 Series

**Superior driving performance backed by the highest quality!**

## Main features of the 800/700 series

### Environmentally friendly

- The EMC filter reduces electromagnetic noise generated by the inverter. (Embedded in the FR-A800 and F800 series inverters.)
- AC and DC reactors can be connected to suppress the harmonic current to the power supply and to improve the power factor.
- The inverters are compliant with the restriction of hazardous substances (RoHS) directive of EU and friendly to people and to the environment.

### Drive performance

- The inverters provide powerful and consistent driving.
- The inverters can drive more highly efficient IPM motors (magnet motors) as well as induction motors. The inverters provide the solution to your further energy saving needs. (FR-A800, F800, and F700PJ series) The highly accurate PM sensorless vector control of the FR-A800 series achieves productivity improvement and energy saving at the same time.

### Long-life and easy maintenance

- Long-life cooling fan\*<sup>1</sup> and long-life capacitor\*<sup>1+2</sup> are incorporated (design life: 10 years)  
\*1: Surrounding air temperature: 40°C on yearly average (free from corrosive gas, flammable gas, oil mist, dust and dirt).  
The design life is a calculated value and is not a guaranteed product life.  
\*2: Output current: 80% of the rated inverter current.
- Degradation degrees of the main circuit capacitor, control circuit capacitor, and inrush current limit resistor can be monitored. The inverter self diagnoses the degradation degree and outputs a warning, allowing trouble to be prevented.
- Upgrading to the succeeding models is easy with the adoption of a removable control circuit terminal block. (FR-A800, F800, and E700 series)
- Cooling fan replacement is performed in simple steps. Maintenance of the inverter is easy.

### Easy-to-use

- An operation panel is mounted as standard on all models.
- The Mitsubishi's setting dial is used.
- Use FR Configurator or FR Configurator2 to facilitate operations from start-up to maintenance.



Advanced functionality and high-performance inverter

## FR-A800 Series

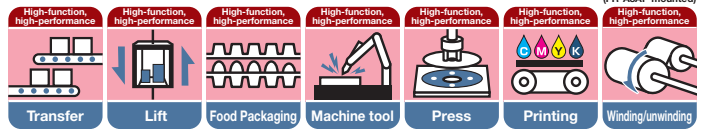

## Features

### Leading drive performance

- The enhanced Real sensorless vector control and vector control achieves improved speed response and high-speed operation.
- The PM motor auto tuning function enables operation of other manufacturers' permanent magnet (PM) motors.

### Security & safety

- Controls with safety functions can be easily performed. (Safety stop function)
- 24 VDC control power input is equipped as standard. The parameter setting and communication operation can be done without turning ON the main power.
- The operating status immediately before the protective function is activated can be stored with the trace function, facilitating the trouble analysis at a separate location by using a USB memory device and the inverter setup software (FR Configurator2).

### Easy setup & easy to use

- A USB host connector (A type) is equipped. Parameters can be copied to commercial USB memory devices.
- Highly reliable and easily wired spring clamp terminals have been adopted for control circuit terminals.
- Parameter setting mode can be changed to the group parameter mode, which provides intuitive and simple parameter settings. (The conventional parameter setting mode is selected by default.)

### Eco-friendly factories

- With Optimum excitation control, the excitation current is constantly adjusted to drive the motor in the most efficient method which leads to energy saving.
- The 315K or higher models are inverter-converter separated types,



which are suitable for power regeneration. Select the FR-CC2 converter unit according to the connected motor capacity (refer to page 10).

### System support

- Rated current and four different overload capacity ratings (SLD rating, LD rating, ND rating, and HD rating) can be selected with parameters. (Multiple rating)
- Parameters and setting frequency can be changed at the program, and the inverter control based on the machine specifications is possible by the PLC function.
- A lineup of products compatible with the IP55 (400 V class) equipped with the DC reactor is available. Inverters can be installed nearby the machine.

### Environmental adaptability

- A built-in noise filter (EMC filter), the newly developed drive technology, and the power supply technology minimize the EMI emitted from inverters.

## Model

FR - A 8 2 0 - 0.4K - 1

Symbol	Voltage class
2	200 V class
4	400 V class

Symbol	Structure, functionality
0	Standard model <sup>*3</sup>
2	Separated converter type <sup>*4</sup>
6	IP55 compatible model

Symbol <sup>*2</sup>	Description
0.4K to 500K	ND rated inverter capacity (kW)
00023 to 12120	SLD rated inverter current (A)

Symbol	Type
-1	FM
-2	CA <sup>*2</sup>

Symbol	Circuit board coating (IEC60721-3-3 3C2/3S2 compatible)	Plated conductor
None	Without	Without
-60	With	Without
-06	With	With

Inverter model	Inverter capacity
FR-A820	0.4 kW to 90 kW
FR-A840	0.4 kW to 280 kW
FR-A842	315 kW to 500 kW
FR-A846	0.4 kW to 18.5 kW

\*The FR-A846-22K to 132K are to be released soon.

<sup>\*1</sup>: IP55 compatible models have LD and ND rating types only. However, the SLD rated current of standard models is used to represent the model.  
<sup>\*2</sup>: For the CA-type, the monitor output terminal FM/CA operates as terminal CA (analog current output 0 to 20 mADC), not as terminal FM (pulse train output).  
<sup>\*3</sup>: For the 75K or higher inverter, always connect a DC reactor (FR-HEL), which is available as an option. Select a DC reactor according to the applied motor capacity.  
<sup>\*4</sup>: Always install the converter unit (FR-CC2). (Not required when a high power factor converter (FR-HC2) is used.)

## Specifications

Control method	Soft-PWM control, high carrier frequency PWM control (selectable among V/F control, Advanced magnetic flux vector control, Real sensorless vector control), Optimum excitation control, vector control <sup>*1</sup> , and PM sensorless vector control
Starting torque	SLD rating: 120% 0.3 Hz, LD rating: 150% 0.3 Hz, ND rating: 200% <sup>*2</sup> 0.3 Hz, HD rating: 250% <sup>*2</sup> 0.3 Hz (with Real sensorless vector control or vector control <sup>*1</sup> )
Output frequency range	0.2 to 590 Hz (Up to 400 Hz with Advanced magnetic flux vector control, Real sensorless vector control, vector control <sup>*1</sup> or PM sensorless vector control)
Regenerative braking torque <sup>*3</sup> (ND rating)	Maximum value/permissible duty 200 V class <sup>*4</sup> : 0.4K to 1.5K..... 150%3%ED 11K to 55K..... 20% continuous 400 V class <sup>*5</sup> : 0.4K to 7.5K..... 100%2%ED 11K to 55K..... 20% continuous 75K or higher..... 10% continuous 75K or higher..... 10% continuous
Acceleration/deceleration time setting	0 to 3600 s (up to three types of accelerations and decelerations can be set individually.)
Multi-speed	15 speeds
Speed command	0 to 5 VDC, 0 to 10 VDC, 0 to ±5 VDC, 0 to ±10 VDC, 4 to 20 mA, digitally set with pulse train input, operation panel or parameter unit, 4-digit BCD or 16-bit binary (when using optional FR-A8AX)
Alarm output	1 changeover contact (230 VAC, 0.3 A, 30 VDC, 0.3 A), open collector output, alarm code (4-bit) output
Output signal	Five types of open collector outputs and two types of contact output (1 changeover contact) can be selected from inverter running, up to frequency, frequency detection, operation ready, overload warning, error output and alarm, etc.
Monitor function	One type can be selected from output frequency, motor current (steady or peak value), output voltage, operation speed, motor torque, converter output voltage, regenerative brake duty, input power, output power and load meter, etc. Pulse train output (1440 pulses/s 2 mA) and analog output (-10 to 10 VDC)
Restart after instantaneous power failure	Available (reduced voltage method (frequency search selectable))
Removable terminal block	Used for control circuit terminals
Communication function	RS-485 supported (Mitsubishi inverter protocol, MODBUS <sup>®</sup> RTU) as standard, CC-Link, CC-Link IE Field Network, PROFIBUS-DP, and DeviceNet <sup>™</sup> options available

<sup>\*1</sup>: Available when an option (FR-ABAP) is mounted.

<sup>\*2</sup>: In the initial setting for the FR-A820-00340(5.5K) or higher and the FR-A840-00170(5.5K) or higher, the starting torque is limited to 150% by the torque limit level.

<sup>\*3</sup>: The regenerative braking torque indicates the average short-time torque (which varies by the motor loss) that is generated when a motor decelerates in the shortest time by itself from the rated speed. When a motor decelerates from a speed higher than the rated speed, the average deceleration torque decreases. When the regenerative power is large, use an option brake unit.

<sup>\*4</sup>: The following performance can be attained when FR-ABR (option) is connected: 150% torque and 10%ED for 0.4K and 0.75K, 100% torque and 10%ED for 1.5K to 7.5K, 100% torque and 6%ED for 11K to 22K.

<sup>\*5</sup>: The following performance can be attained when FR-ABR-H (option) is connected: 100% torque and 10%ED for 0.4K and 0.75K, 100% torque and 6%ED for 11K to 22K.

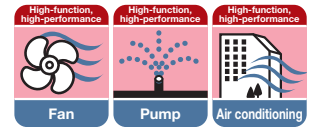

## Features

### Energy saving

- Advanced optimum excitation control, which has been newly developed, provides a large starting torque while maintaining the motor efficiency under the conventional Optimum excitation control.
- The tuning function enables operation of other manufacturers' induction motors and PM motors, which increases the use in the energy saving applications.
- With the 24 VDC external power supply, the input MC signal can be turned OFF after the motor is stopped, and turned ON before activating the motor. The inverter enables self power management to reduce standby power.

### Functions ideal for fans and pumps

- The rating can be selected between the two types (LD (light duty) or SLD (superlight duty)) depending on the load of the fan/pump to be used (multiple rating).
- The inverter can perform PID control of the motor operation and control the external equipment at the same time (PID multiple loops). The system cost can be reduced.
- By controlling the pumps connected in parallel (up to four pumps) by the PID control, water volume, etc. can be adjusted by one inverter (multi-pump function).
- Foreign matter on the impellers or fans of pumps can be removed by repeating forward/reverse rotation and stopping of the motor (cleaning function).

### Security & safety

- Controls with safety functions can be easily performed (safety stop function).
- With the 24 VDC external power supply, the parameter setting and communication operation can be done without turning ON the main circuit power.



- The inverter is equipped with a temperature sensor, which outputs a signal when the internal temperature is high.
- The operating status immediately before the protective function is activated can be stored (trace function). A USB memory device and the inverter setup software (FR Configurator2) facilitate the trouble analysis at a separate location.

### Compatibility with the environment

- A built-in noise filter (EMC filter) minimizes the EMI emitted from inverters.
- By installing a DC reactor (FR-HEL), which is available as an option, they can conform to the Architectural Standard Specifications (2013 revision) supervised by the Ministry of Land, Infrastructure, Transport and Tourism of Japan.

### Easy setup & easy to use

- A USB host connector (A type) is equipped. Parameters can be copied to commercial USB memory devices.
- Highly reliable and easily wired spring clamp terminals have been adopted for control circuit terminals.

## Model

FR - F 8 2 0 - 0.75K - 1

Symbol	Voltage class	Symbol	Structure, functionality	Symbol	Description	Symbol	Type	Symbol	Circuit board coating (IEC60721-3-3 9C2/9S2 compatible)	Plated conductor	Inverter model	Inverter capacity
2	200 V class	0	Standard model <sup>*2</sup>	0.75K	LD rated inverter capacity (kW)	-1	FM	None	Without	Without	FR-F820	0.75 kW to 110 kW
4	400 V class	2	Separated converter type <sup>*3</sup>	00023	SLD rated inverter current (A) to 12120	-2	CA <sup>*1</sup>	-60	With	Without	FR-F840	0.75 kW to 315 kW
								-06	With	With	FR-F842	355 kW to 560 kW

\*1: For the CA-type, the monitor output terminal FM/CA operates as terminal CA (analog current output 0 to 20 mA DC), not as terminal FM (pulse train output).

\*2: For the 75K or higher inverter, always connect a DC reactor (FR-HEL), which is available as an option. Select a DC reactor according to the applied motor capacity.

\*3: Always install the converter unit (FR-CC2). (Not required when a high power factor converter (FR-HC2) is used)

## Specifications

Control method	Soft-PWM control, high carrier frequency PWM control (selectable among V/F control (Optimum excitation control), Advanced magnetic flux vector control (Advanced optimum excitation control), and PM motor control)	
Starting torque	Induction motor	120% 0.5 Hz (Advanced magnetic flux vector control)
	IPM motor	50%
Output frequency range	0.2 to 590 Hz (Up to 400 Hz with Advanced magnetic flux vector control, and PM motor control.)	
Regenerative braking torque (Maximum value/ permissible duty)	Induction motor	0.75K to 55K...15% continuous, 75K or higher...10% continuous
	IPM motor	Approximately 5% (1.5K or lower...Approximately 10%) <sup>*1</sup>
Acceleration/deceleration time setting	0 to 3600 s (up to three types of accelerations and decelerations can be set individually.)	
Multi-speed	15 speeds	
Speed command	0 to 5 VDC, 0 to 10 VDC, 0 to ±5 VDC, 0 to ±10 VDC, 4 to 20 mA, pulse train input digitally set with operation panel or parameter unit, 4-digit BCD or 16-bit binary (when using optional FR-A8AX)	
Alarm output	1 changeover contact (230 VAC, 0.3 A, 30 VDC, 0.3 A), open collector output, alarm code (4-bit) output	
Output signal	Five types of open collector outputs and two types of contact outputs (1 changeover contact) can be selected from inverter running, up to frequency, frequency detection, operation ready, overload warning, error output and alarm, etc.	
Monitor function	One monitored item can be selected from output frequency, motor current (steady or peak value), output voltage, operation speed, converter output voltage, input power, output power and load meter, etc. Pulse train output (1440 pulses/s 2 mA) and analog output (0 to 10 VDC)	
Restart after instantaneous power failure	Available (reduced voltage method (frequency search selectable))	
Removable terminal block	Used for control circuit terminals	
Communication function	RS-485 supported (Mitsubishi inverter protocol, MODBUS <sup>®</sup> RTU) as standard, CC-Link, CC-Link IE Field Network, PROFIBUS-DP, DeviceNet <sup>™</sup> options available	

\*1: Regenerative braking torque is the average short-time torque when a motor decelerates to a stop from the rated speed in the shortest time. (It varies with the motor loss.) It is not a continuous regenerative torque. The average deceleration torque decreases when a motor decelerates from a speed higher than the rated speed. When the regenerative power is large, use a braking option.

Simple, powerful, and compact inverter

## FR-E700 Series

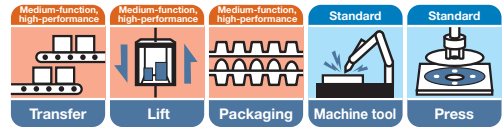

### Features

#### Pursuing the best performance—top level of driving performance in a compact body

- Advanced magnetic flux vector control enables accurate start-ups for general-purpose industrial machines. (200% 0.5 Hz (3.7K or lower))
- Improved short-time permissible overload (200% for 3s) provides powerful and consistent driving.
- Torque limit and current limit functions are available.

#### Easy-to-use (Outstanding operability and diverse expandability)

- The non-slip, adaptable scroll speed setting dial allows for quick jumps or precise increments based on turning speed.
- The operation mode can be selected in simple steps.
- This series has USB which enables easy setting from a personal computer with FR Configurator.
- Plug-in options are available to add digital inputs/analog outputs and to support different communication networks.
- For the customers who need more than the standard terminals, the option terminal blocks, such as the 2-port RS-485 terminal block, are available.
- The inverters with 0.4K or higher capacity have plug-in regenerative brake transistors, which enable use for lift applications.
- An enclosure surface operation panel can be attached on an enclosure surface and is available as an option. The operation panel of the FR-E500 series can be also connected.

#### Compact and space-saving

- The mounting dimensions are the same as the conventional FR-E500 model to keep backwards compatibility.
- Space can be saved with the side-by-side installation.



#### Improved reliability and easy maintenance

- Spring clamp terminals provide high reliability and easy wiring. (FR-E700-SC/NF/NC)
- Shutoff circuit (hardware) securely provides emergency output shutoffs. The inverter with the safety stop function can comply with the safety standards without incurring too much cost. (FR-E700-SC/NF/NC)
- The lives of the cooling fan and capacitor have been extended.
- Using the self-diagnosis function, the part life warning can be output and the degree of deterioration can be monitored to prevent malfunction.
- The removable control circuit terminal block simplifies replacement work.

#### Environmentally friendly

- Filter options reduce the electromagnetic noise generated at the inverter and enables compliance with the harmonic suppression guidelines of Japan.

### Model

FR - E 7 2 0 - 3.7K

Symbol	Voltage class	Symbol	Number of phases	Symbol	Applicable motor capacity	Symbol	Control circuit terminal specification	Inverter model	Inverter capacity
2	200 V class	None	Three-phase input	0.1K to 15K	Represents the capacity (kW)	None	Standard control circuit terminal (screw type)	FR-E720(SC)(NF)(NC)	0.1 kW to 15 kW
4	400 V class	S	Single-phase input			SC	Safety stop function model	FR-E740(SC)(NF)(NC)	0.4 kW to 15 kW
1	100 V class	W	Single-phase input (double-voltage output)			NF	FL remote communication model	FR-E720S(SC)*	0.1 kW to 2.2 kW
						NC	CC-Link communication model	FR-E710W*	0.1 kW to 0.75 kW

\* The output of the single-phase 200 V and single-phase 100 V input models is three-phase 200 V.

### Specifications

Control method	Soft-PWM control, high carrier frequency PWM control (V/F control, General-purpose magnetic flux vector control, Advanced magnetic flux vector control or Optimum excitation control can be selected)
Starting torque	200%0.5 Hz (3.7K or lower) 150% 0.5 Hz (5.5K or higher) with Advanced magnetic flux vector control
Output frequency range	0.2 to 400 Hz
Regenerative braking torque*1	0.1K/0.2K.....150%, 0.4K/0.75K.....100%, 1.5K.....50%, 2.2K or higher.....20%
Acceleration/deceleration time setting	0 to 3600 s (up to two types of accelerations and decelerations can be set individually.)
Multi-speed	15 speeds
Speed command*2	0 to 5 VDC, 0 to 10 VDC, 4 to 20 mA, digital setting with setting dial, digital setting with operation panel or parameter unit
Safety stop*3	Output shutoff S1 and S2
Alarm output*4	1 changeover contact (230 VAC 0.3 A, 30 VDC 0.3 A), open collector output
Output signal*4	Two types of open collector outputs and one type of contact output (1 changeover contact) can be selected from inverter running, up to frequency, frequency detection, output current detection, operation ready, overload warning, fault output, and alarm, etc.
Monitor function	One monitored item can be selected from output frequency, motor current (steady or peak value), output voltage, frequency setting value, motor torque, converter output voltage, regenerative brake duty, and output power, etc. Pulse train output (1440 pulse/s 1 mA) <sup>5</sup> , analog output 0 to 10 VDC (when using optional analog terminal block), pulse output (when using optional pulse train terminal block)
Restart after instantaneous power failure	Available (reduced voltage method (frequency search selectable))
Removable terminal block	Used for control circuit terminals
Communication function	RS-485 supported (Mitsubishi inverter protocol and MODBUS <sup>®</sup> RTU) as standard. CC-Link, PROFIBUS-DP, DeviceNet <sup>™</sup> , LonWorks <sup>®</sup> options available. FL remote communication and CC-Link communication models also available.

\*1: Braking torque is the average short-time torque when a motor decelerates to a stop from 60 Hz in the shortest time. (It varies with the motor loss.) It is not a continuous regenerative torque. The average deceleration torque becomes lower when a motor decelerates from a frequency higher than the base frequency. The inverter is not equipped with a built-in brake resistor. Use an optional brake resistor for an operation with large regenerative power. (Not available for 0.1K and 0.2K.) Brake unit (FR-BU2) can be also used.

\*2: For the FL remote communication model, commands can be input from the operation panel or through FL remote communication. For the CC-Link communication model, commands can be input from the operation panel or through CC-Link communication.

\*3: Not available for the standard model.

\*4: The FL remote communication model and the CC-Link communication model have only one open collector output terminal. (For the FL remote communication model, the terminal is fixed to output the safety monitor output signal (not selectable).)

\*5: Not available for the FL remote communication model and the CC-Link communication model.

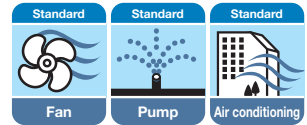

## Features

### ■ Suitable for both the general-purpose motor and the IPM motor

- This series can drive both a general-purpose motor and an IPM motor. Switching between the two motor controls is simple—just a single parameter setting. Initially, a general purpose motor could be used, then upgraded to an IPM motor without switching this inverter, leading to lower cost of equipment.

### ■ Environmentally friendly

- Power factor improving DC reactor, common mode choke (line noise filter), capacitive filter (radio noise filter) are all essential for air conditioning applications, and all of these are included in the Filterpack. The inverter with Filterpack (FR-F700PJ-□F) is also available.

The wiring with different options is no longer required.

- Less wiring and smaller space is required when Filterpack is used. Filterpack also enables compliance with the harmonic suppression guideline, the architectural standard specifications (electrical installation), and the architectural standard specifications (machinery installation) (2013 revisions) in Japan.



The inverter with Filterpack

### ■ Easy-to-use

- The following functions provide the ideal operation for fans and pumps (PID control, Optimum excitation control, regeneration avoidance, and automatic restart after instantaneous power failure).

### ■ Improved reliability and easy maintenance

- Spring clamp terminals provide high reliability and easy wiring.
- The lives of the cooling fan and capacitor have been extended.
- Using the self-diagnosis function, the component life warning can be output and the degree of deterioration can be monitored to prevent malfunction.

## Model

FR - F 7 4 0 P J - 3.7K □

Symbol	Voltage class
2	200 V class
4	400 V class

Symbol	Inverter capacity
0.4K to 15K	Represents the capacity (kW)

Symbol	Filterpack
None	Without
F	With*

Inverter model	Inverter capacity
FR-F720PJ	0.4 kW to 15 kW
FR-F740PJ	0.4 kW to 15 kW

#### <Precautions>

- Never drive an IPM motor in the IM drive setting.
  - Use the same IPM motor capacity as the inverter capacity.
  - For IPM motor, use an MM-EFS or MM-EF series motor.
- Please contact us regarding a combination with other manufacturer's IPM motor.

- \*The inverter with Filterpack consists of an inverter and a Filterpack. The inverter carries the rating plate, "FR-F700PJ-□K," and the Filterpack carries the rating plate "FR-BFP2-□K."

## Specifications

Control method	Soft-PWM control, high carrier frequency PWM control (V/F control, General-purpose magnetic flux vector control, Optimum excitation control, and IPM motor control can be selected)
Starting torque	General-purpose motor control: 120% (at 1 Hz) with General-purpose magnetic flux vector control and slip compensation IPM motor control: 50%
Output frequency range	0.2 to 400 Hz
Regenerative braking torque	General-purpose motor control: 15%*1 IPM motor control: 5% (10% for 1.5 kW or lower)*1
Acceleration/deceleration time setting	0.1 to 3600 s (up to two types of accelerations and decelerations can be set individually.)
Multi-speed	15 speeds
Speed command	0 to 5 VDC, 0 to 10 VDC, 4 to 20 mA, digital input with setting dial, digital setting with operation panel or parameter unit
Alarm output	1 changeover contact (230 VAC 0.3 A, 30 VDC 0.3 A), open collector output
Output signal	One type of open collector output and one type of contact output (1 changeover contact) can be selected from inverter running, up to frequency, frequency detection, output current detection, operation ready, overload warning, fault output, and alarm, etc.
Monitor function	One monitored item can be selected from output frequency, motor current (steady or peak value), output voltage, frequency setting value, converter output voltage, regenerative brake duty, and output power, etc. Pulse train output (1440 pulses/s 1 mA)
Restart after instantaneous power failure	Available (reduced voltage method (frequency search selectable))
Communication function	RS-485 supported (Mitsubishi inverter protocol and MODBUS®RTU) as standard

\*1: Regenerative braking torque is the average short-time torque when a motor decelerates to a stop from the rated speed in the shortest time. (It varies with the motor loss.) It is not a continuous regenerative torque. The average deceleration torque becomes lower when a motor decelerates from a speed higher than the rated speed. When the regenerative power is large, use a braking option.

## Simple and compact inverter FR-D700 Series

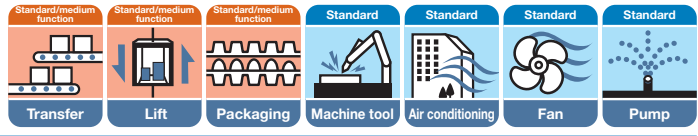

### Features

#### ■ Improved reliability and easy maintenance

- Spring clamp terminals provide high reliability and easy wiring.
- Shutoff circuit (hardware) securely provides emergency output shutoffs.
- The inverter with the safety stop function can comply with the safety standards without incurring too much cost.
- Parameter writing/reading can be restricted with a 4-digit password.
- The lives of the cooling fan and capacitor have been extended.
- Using the self-diagnosis function, the part life warning can be output and the degree of deterioration can be monitored to prevent malfunction.

#### ■ Pursuing the best performance

- The General-purpose magnetic flux vector control and the auto tuning function enable reliable operation in applications that require large starting torque. (150% 1 Hz, 200% 3 Hz (3.7K or lower with the slip compensation))

#### ■ Easy-to-use (pursuing the easy operation)

- The non-slip, adaptable scroll speed setting dial allows for quick jumps or precise increments based on turning speed.
- Setting can be made easily from a personal computer with FR Configurator.



- An enclosure surface operation panel, which can be attached on an enclosure surface, is available as an option. Operation panel for the FR-E500 series inverters can be also connected.
- The inverters with 0.4K or higher capacity have built-in regenerative brake transistors, and their usage can be extended to a lift application.

#### ■ Environmentally friendly

- Filter options reduce the electromagnetic noise generated at the inverter and enables the compliance with the harmonic suppression guidelines of Japan.

### Model

FR - D 7 4 0 - 0.4K

Symbol	Voltage class
1	100 V class
2	200 V class
4	400 V class

Symbol	Number of phases
None	Three-phase input
S	Single-phase input
W	Single-phase input (double-voltage output)

Symbol	Applicable motor capacity
0.1K to 15K	Represents the capacity (kW)

Inverter model	Inverter capacity
FR-D720	0.1 kW to 15 kW
FR-D740	0.4 kW to 15 kW
FR-D720S*	0.1 kW to 2.2 kW
FR-D710W*	0.1 kW to 0.75 kW

\*The output of the single-phase 200 V and single-phase 100 V input models is three-phase 200 V.

### Specifications

Control method	Soft-PWM control, high carrier frequency PWM control (V/F control, General-purpose magnetic flux vector control, Optimum excitation control can be selected)
Starting torque	150% 1 Hz, 200% 3 Hz (3.7K or lower) with General-purpose magnetic flux vector control and slip compensation
Output frequency range	0.2 to 400 Hz
Regenerative braking torque <sup>*1</sup>	0.1K/0.2K.....150%, 0.4K/0.75K.....100%, 1.5K.....50%, 2.2K or higher.....20%
Acceleration/deceleration time setting	0 to 3600 s (up to two types of accelerations and decelerations can be set individually.)
Multi-speed	15 speeds
Speed command	0 to 5 VDC, 0 to 10 VDC, 4 to 20 mA, digital input with setting dial, digital setting with operation panel or parameter unit
safety stop	Monitor output S0, output shutoff S1 and S2
Alarm output	1 changeover contact (230 VAC 0.3 A, 30 VDC 0.3 A), open collector output
Output signal	One type of open collector output and one type of contact output (1 changeover contact) can be selected from inverter running, up to frequency, frequency detection, output current detection, operation ready, overload warning, fault output, and alarm, etc.
Monitor function	One monitored item can be selected from output frequency, motor current (steady or peak value), output voltage, frequency setting value, converter output voltage, regenerative brake duty, and output power, etc. Pulse train output (1440 pulses/s 1 mA)
Restart after instantaneous power failure	Available (reduced voltage method (frequency search method selectable))
Communication function	RS-485 (Mitsubishi inverter protocol and MODBUS <sup>®</sup> RTU) supported as standard

\*1: Braking torque is the average short-time torque when a motor decelerates to a stop from 60 Hz in the shortest time. (It varies with the motor loss.) It is not a continuous regenerative torque. The average deceleration torque becomes lower when a motor decelerates from a frequency higher than the base frequency. The inverter is not equipped with a built-in brake resistor. Use an option brake resistor for an operation with large regenerative power. Brake unit (FR-BU2) can be also used.





## Features

### Easy-to-use

- The number of wires in the main circuit has been reduced to approx.40% and the installation area has been reduced to approx.60% (for 7.5K) compared to the conventional configuration with stand-alone common converters. Use this model to save the wiring and the space.
- For easy replacement, the installation size is the same as the conventional model (FR-A201).
- The braking circuit is built-in for this inverter, so the selection procedure for a braking option is no longer required.
- The total cost is reduced compared to the conventional system (inverter + power regenerative converter + AC reactor). Less heat is generated in this inverter because the regenerative power is returned to the power supply, leading to energy savings.

### Pursuing the best performance

- It has excellent braking capacity. (The regenerative braking torque is 100% for continuous operation and 150% for 60 s.)

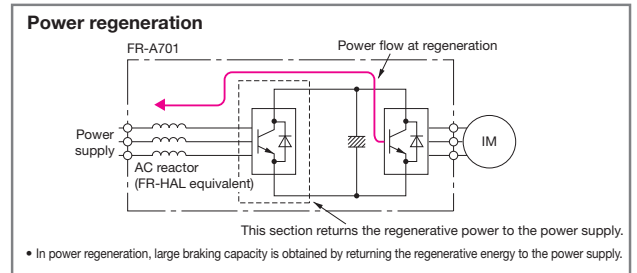
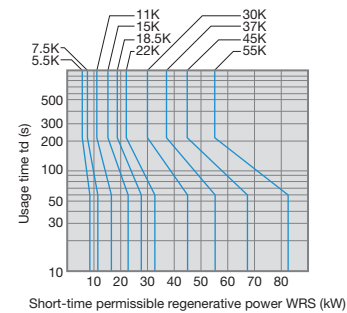

## Model

FR - **A721** - **5.5K**

Symbol	Voltage class	Symbol	Applicable motor capacity
A721	200 V class	5.5K to 55K	Represents the capacity (kW).
A741	400 V class		

Applicable motor (kW)	5.5	7.5	11	15	18.5	22	30	37	45	55
Three-phase 200 V class FR-A721-□□	●	●	●	●	●	●	●	●	●	●
Three-phase 400 V class FR-A741-□□	●	●	●	●	●	●	●	●	●	●

● : Available

## Specifications

Control method	Soft-PWM control, high carrier frequency PWM control (V/F control, Advanced magnetic flux vector control or Real sensorless vector control can be selected) Vector control*1
Starting torque	150% 0.3 Hz with Real sensorless vector control or vector control*1
Output frequency range	0.2 to 400 Hz (Up to 120 Hz with Real sensorless vector control or vector control*1)
Regenerative braking torque	Maximum value/permissible duty 100% continuous 150% 60 s
Acceleration/deceleration time setting	0 to 3600 s (up to three types of accelerations and decelerations can be set individually.)
Multi-speed	15 speeds
Speed command	0 to 5 VDC, 0 to 10 VDC, 0 to ±5 VDC, 0 to ±10 VDC, 4 to 20 mA, digitally set with pulse train input, operation panel or parameter unit, 4-digit BCD or 16-bit binary (when using optional FR-A7AX)
Alarm output	1 changeover contact (230 VAC, 0.3 A, 30 VDC, 0.3 A), open collector output, alarm code (4-bit) output
Output signal	Five types of open collector outputs and two types of contact output (1 changeover contact) can be selected from inverter running, up to frequency, instantaneous power failure (undervoltage), frequency detection, operation ready, overload warning, error output and alarm, etc.
Monitor function	One type can be selected from output frequency, motor current, output voltage, operation speed, motor torque, converter output voltage (steady or peak value), input power, output power and load meter, etc. Pulse train output (1440 pulses/s 2 mA) and analog output (0 to 10 VDC)
Restart after instantaneous power failure	Available (reduced voltage method (frequency search selectable))
Removable terminal block	Used for control circuit terminals
Communication function	RS-485 supported (Mitsubishi inverter protocol and MODBUS®RTU) as standard, CC-Link, PROFIBUS-DP, DeviceNet™, LonWorks®, and SSCNET III, options available

\*1: Available when an option (FR-A7AP/FR-A7AL) is mounted.

Premium high-efficiency IPM motor

## MM-EFS/MM-THE4 Series

Compatible inverter

FR-F800  
FR-F700PJ

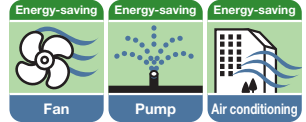

### Features

#### Energy savings with speed control

- The consumed power of a variable-torque load, such as fans, pumps, and blowers, is proportional to the cube of its rotation speed. Using this characteristic, the consumed power is reduced when air volume is adjusted with speed control.

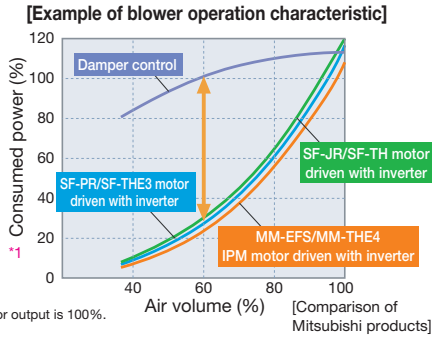

#### IE4-equivalent efficiency level

- A premium high-efficiency IPM motor "MM-EFS series/MM-THE4 series" provides even better efficiency that is equivalent to IE4 (super premium efficiency), the highest efficiency class\*.

\*As of March 2013

#### Energy savings with IPM motor

##### High efficiency achieved with IPM motors

- The IPM motors that have permanent magnets embedded in their rotors are even more efficient than the high-performance energy-saving motors.

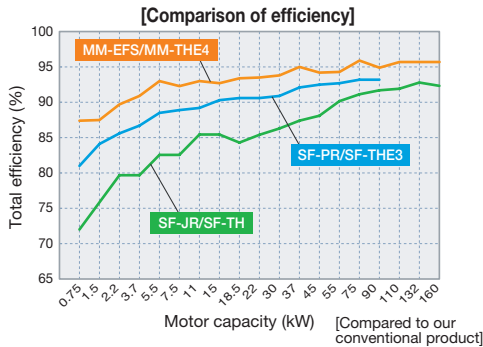

IEC 60034-30 Efficiency class	Efficiency of Mitsubishi motors	
	General-purpose motor	IPM motor
IE4 (super premium efficiency)*	—	Premium high-efficiency IPM (MM-EFS/MM-THE4)
IE3 (premium efficiency)	Super line premium series (SF-PR, SF-THE3)	—
IE2 (high efficiency)	High-performance energy-saving motor (SF-HR)	—
IE1 (standard efficiency)	Standard three-phase motor (SF-JR)	—
Below the class	—	—

\*3: The details of IE4 can be found in IEC 60034-31.

#### Smooth replacement from a general-purpose motor (with the same installation size)

- The frame number is the same (same size) as the Mitsubishi general-purpose motors (4-pole SF-JR/SF-HR series). Replacement is easy as the installation sizes are compatible. (55kW or lower)

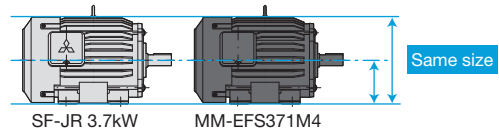

#### Why is the IPM motor more efficient?

- No current flows to the rotor (secondary side), and no secondary copper loss is generated.
- Magnetic flux is generated with permanent magnets, and less motor current is required.
- Embedded magnets provide reluctance torque\*2, and the reluctance torque can be applied.

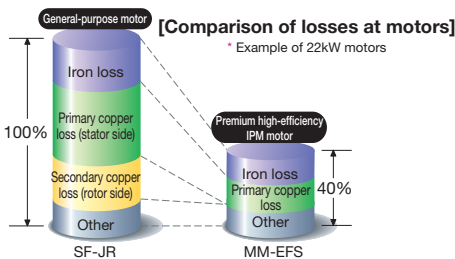

#### Motor structure (section view)

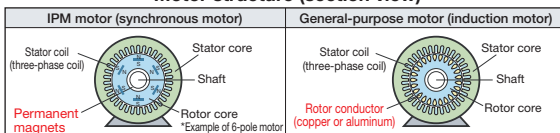

\*2: Reluctance torque  
Reluctance torque occurs due to magnetic imbalance on the rotor

## ■ Air conditioning in a building [Inverter + general-purpose motor (SF-JR)] → [Inverter + IPM motor (MM-EFS)]

(Conditions: The electricity cost is 14 yen/kWh. The CO<sub>2</sub> emission is 1,000 kWh ≈ 0.55 ton - CO<sub>2</sub> emission)

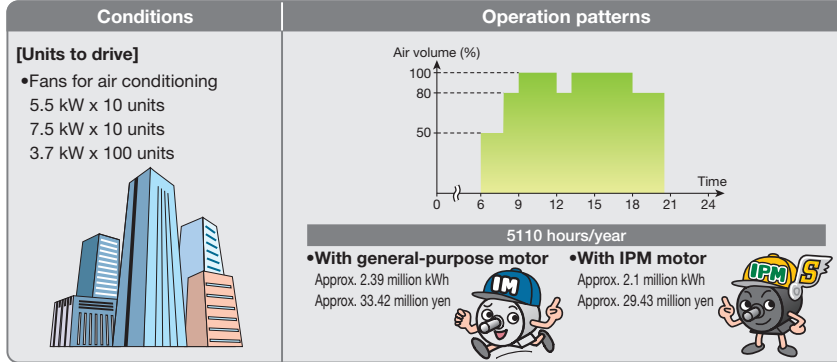

### The effects of replacing conventional systems with inverter driven IPM motors

• **Annual energy saving effect (differences in the amount and cost)**

Approx. 0.28 million kWh

**Approx. 3.99 million yen**

• **Annual CO<sub>2</sub> emission reduction**

Approx. 0.28 million kWh

**157 tons**

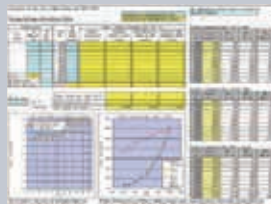

### Easy calculation of the energy saving effect

(IPM energy savings simulation file)

This Excel® simulation file enables calculation of the energy saving effect and CO<sub>2</sub> reduction rate achieved by replacing commercial power supply (damper/valve control) operation with IPM motor operation, general-purpose motor operation by inverter, or high-efficiency motor operation by inverter. This file requires inputs such as the motor capacity, quantity, air volume, the operating time, the annual operating time, the electricity cost, and the CO<sub>2</sub> conversion coefficient. When you input the initial cost and the bearing replacement cost, you can calculate how many years and months it will take to recover the initial cost.

◀ Example of the energy savings calculation sheet Ver. 1.31

Download the latest version from the Mitsubishi Electric FA Global Website.

## Model

[ 55 kW or lower ]

MM - EFS 7 1 M 4

Symbol	Output	Symbol	Rated speed <sup>①</sup>	Symbol	Voltage class	Symbol	Specifications <sup>②</sup>	Symbol	Specifications <sup>②</sup>
See motor models in table below	See rated output in table below	1M	1500 r/min	None	200 V	None	Standard model	None	Standard model
				4	400 V	Q	Class B	P1	Outdoor type

\*1: It can be also used for an application with the rated speed 1800 r/min.  
 \*2: The outdoor type and class B are semi-standard models.

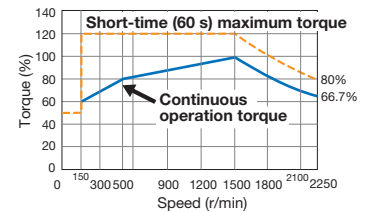

[ 75 kW or higher ]

MM - THE 4

- The motor can be used for applications which required the rated speed of 1500 r/min and 1800 r/min.
- For dedicated motors such as the outdoor type, the long-axis type, the flange type, the waterproof outdoor type, and the salt-damage proof specification type, contact your sales representative.

Rated output (kW)		0.75	1.5	2.2	3.7	5.5	7.5	11	15	18.5	22	30	37	45	55	75	90	110	132	160
Motor model name		7	15	22	37	55	75	11K	15K	18K	22K	30K	37K	45K	55K	—	—	—	—	—
200 V class	MM-EFS□1M	●	●	●	●	●	●	●	●	●	●	●	●	●	●	—	—	—	—	—
400 V class	MM-EFS□1M4	●	●	●	●	●	●	●	●	●	●	●	●	●	●	—	—	—	—	—
200 V class	MM-THE4	—	—	—	—	—	—	—	—	—	—	—	—	—	—	●	—	—	—	—
400 V class	MM-THE4	—	—	—	—	—	—	—	—	—	—	—	—	—	—	●	●	●	●	●

■ Caution

- The IPM motor MM-EFS/MM-THE4 series cannot be driven by the commercial power supply.
- The total wiring length for an IPM motor should be 100 m or less.
- Only one IPM motor can be connected to each inverter.

●: Available —: Not available

Vector inverter  
**FR-V500(L) Series**

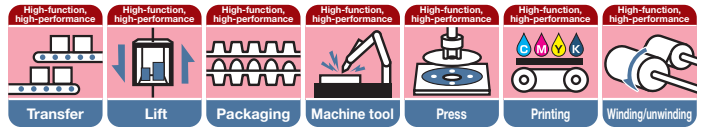

**Features**

**Pursuing the best performance**

- The model adaptive speed control improves the speed command trackability.  
(Speed response 800rad/s (55K or lower), speed control range 1:1500)
- The adaptive magnetic flux observer reduces torque fluctuation caused by changes in the motor temperature. The motor's internal flux can be calculated at a high accuracy, thus improving the torque accuracy.  
(Repeated torque accuracy 5%.)
- The simple gain tuning function eliminates the need to adjust the speed control gain and position loop gain.

**Easy-to-use**

- The machine analyzer function of the inverter setup software (FR Configurator) vibrates the motor to analyze the resonance frequency of the machine. The notch filter function is available to avoid machine resonances.
- The terminal dedicated to encoder signals is equipped as standard.
- Combination with a 1500 r/min dedicated motor (SF-V5RU) is possible with the same capacities.



- Encoder expandability  
The power voltage and output circuit can be selected according to each encoder. (Differential line driver/complementary, separate power supply (5.5/12/24 V) required.)  
The dedicated motor (SF-V5RU) encoder is compatible with a 2048P/R resolution and 12 V power voltage.

**Model**

FR - V520 - 1.5K - [ ]

Symbol	Voltage class	Symbol	Voltage class
V520	200 V class 55K or lower	V520L	200 V class 75K or higher
V540	400 V class 55K or lower	V540L	400 V class 75K or higher

Symbol	Applicable motor capacity
1.5K to 250K	Represents the capacity (kW)

Symbol	Dedicated model
None	Standard model
80	Sensorless vector control model
A1	Dancer control model

Inverter model	Inverter capacity
FR-V520(L)	1.5 kW to 75 kW
FR-V540(L)	1.5 kW to 250 kW

Converter unit  
**FR-CC2 Series**

**Features**

- For the 800 series large-capacity inverters (FR-A800: 315K or higher, FR-F800: 355K or higher), converter section (FR-CC2) and the inverter section are separated. This can contribute to space and cost savings of large capacity systems (except when one converter unit is connected to one inverter).

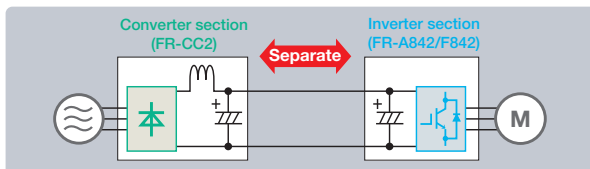

**Model**

- Select the capacity of the converter unit according to the motor capacity.
- The converter unit has a built-in DC reactor.

FR - CC2 - H 355K - 60

Three-phase 400 V class FR-CC2-H□ (with the built-in DC reactor)	315K	355K	400K	450K	500K	560K	630K
	●	●	●	●	●	●	●

● : Available

Symbol	Voltage class
H	400 V class

Capacity	Description
315K to 630K	Applicable motor capacity (kW)

Symbol	Circuit board coating (IEC60721-3-3 3C2/3S2 compatible)	Plated conductor
-60	With	Without
-06	With	With



**Inverter for pressure-resistant explosion-proof type motor**

# FR-B, B3 Series

- This inverter for pressure-resistant explosion-proof type motor, in combination with the Mitsubishi pressure-resistant explosion-proof type motor, has passed the explosion-proof test by the Japanese Ministry of Health, Labour and Welfare.
- Always install the inverter away from the explosive environment.

Variable torque type		
Applicable motor output [kW]	200 V class	400 V class
0.2		
0.4	FR-B-750	FR-B-750
0.75		
1.5	FR-B-1500	FR-B-1500
2.2	FR-B-2200	FR-B-2200
3.7	FR-B-3700	FR-B-3700
5.5	FR-B-5.5K	
7.5	FR-B-7.5K	FR-B-7.5K
11	FR-B-11K	
15	FR-B-15K	FR-B-15K
22	FR-B-22K	FR-B-22K
30	FR-B-30K	FR-B-37K
37	FR-B-37K	
45	FR-B-45K	
55	FR-B-55K	FR-B-55K
75	FR-B-75K	FR-B-75K
90	—	FR-B-90K
110	—	FR-B-110K

Constant torque type		
Applicable motor output [kW]	200 V class	400 V class
0.4	FR-B3-400	FR-B3-H400
0.75	FR-B3-750	FR-B3-H750
1.5	FR-B3-1500	FR-B3-H1500
2.2	FR-B3-2200	FR-B3-H2200
3.7	FR-B3-3700	FR-B3-H3700
5.5	FR-B3-5.5K	FR-B3-H5.5K
7.5	FR-B3-7.5K	FR-B3-H7.5K
11	FR-B3-11K	FR-B3-H11K
15	FR-B3-15K	FR-B3-H15K
18.5	FR-B3-18.5K	FR-B3-H18.5K
22	FR-B3-22K	FR-B3-H22K
30	FR-B3-30K	FR-B3-H30K
37	FR-B3-37K	FR-B3-H37K



**Vector control motor Dedicated motor**

# SF-V5RU

- When used in combination with the vector inverter FR-V500 or the FR-A800/FR-A701 inverter, 100% torque continuous operation is possible from 1500 r/min to the ultra-low speed of 0 r/min.
- An encoder and cooling fan are built-in.
- In addition to the standard type with legs, the flange type and type with brakes can be manufactured.
- It is suitable for winder and unwinder applications. Motors with speed ratio of 1000/2000 r/min, 1000/3000 r/min and 500/2000 r/min specifications are available and they can support applications whose winding diameter greatly changes.

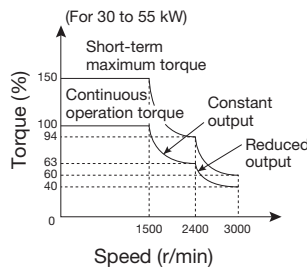
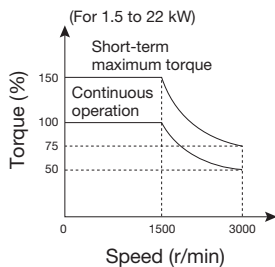

\*The maximum speed for the 55 kW is 2400 r/min.

**Inverter for fans and pumps**

# FR-F700P Series

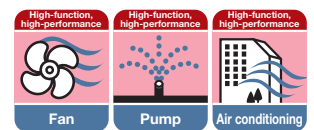

- Optimum excitation control continuously adjusts the excitation current to an optimum level to provide the highest motor efficiency leading to substantial energy savings.
- This series can drive both a general-purpose motor and an IPM motor. Switching between the two motor controls is simple—just a single parameter setting.
- The following functions provide the ideal operation for fans and pumps: variable torque acceleration /deceleration patterns, PID control, commercial power supply switching, adjustable 5 points V/F, continuous operation at an instantaneous power failure, regeneration avoidance function, etc.
- The newly developed built-in EMC filter reduces electromagnetic noise generated from the inverter.
- The lives of the cooling fan and capacitor have been extended. Using the self-diagnosis function, the part life warning can be output and the degree of deterioration can be monitored to prevent malfunction.



**Model** FR - F 7 2 0 P - 3.7K

Symbol	Voltage class
2	200 V class
4	400 V class

Symbol	Applicable motor capacity
0.75K to 560K	Represents the capacity (kW)

Inverter model	Inverter capacity
FR-F720P	0.75 kW to 110 kW
FR-F740P	0.75 kW to 560 kW

# Option Series

## Option lineup

A wide variety of options which improve function and performance, such as installation attachments, are available for the FR series lineup.

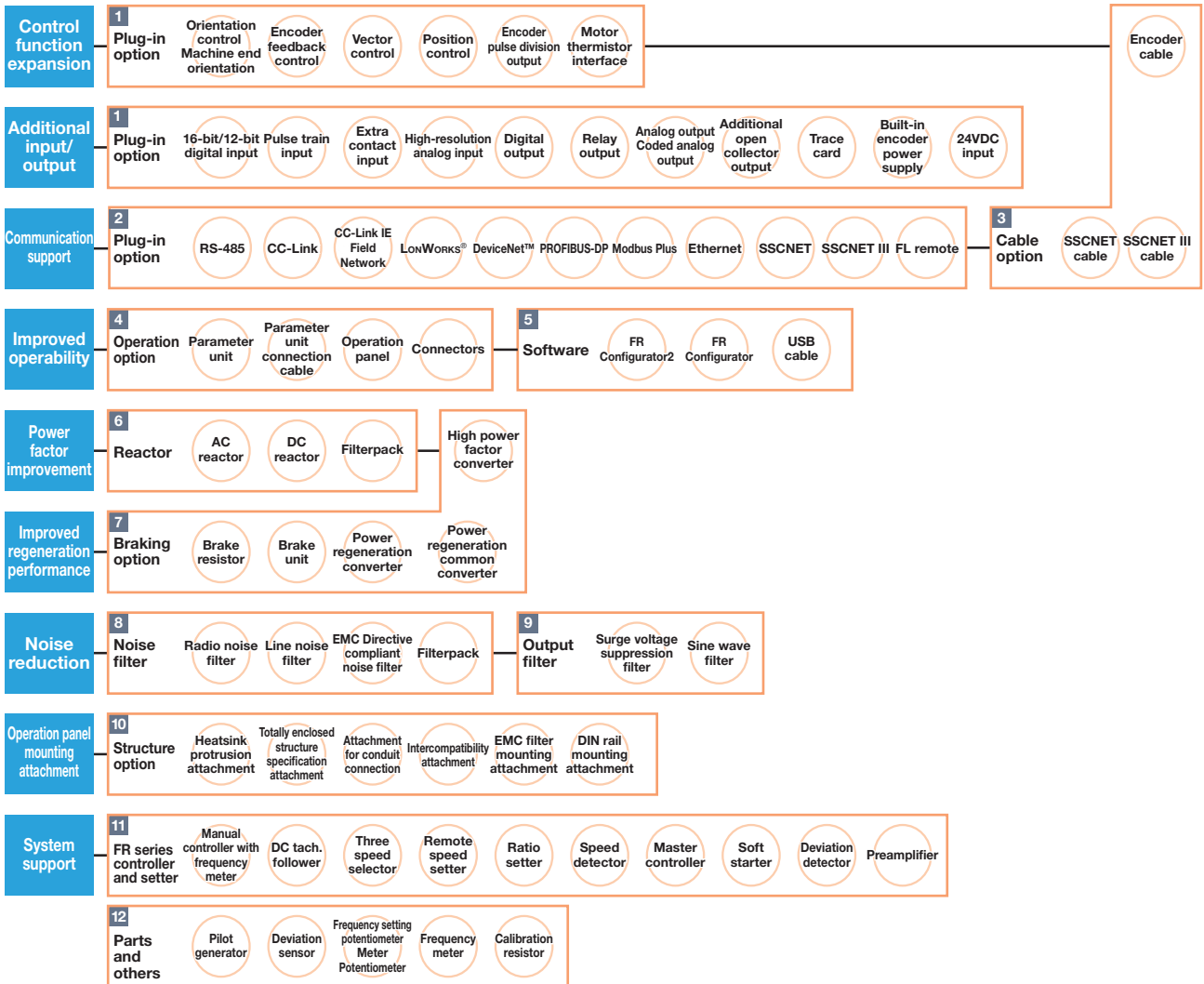

## Option connections

The main option connections are shown below.

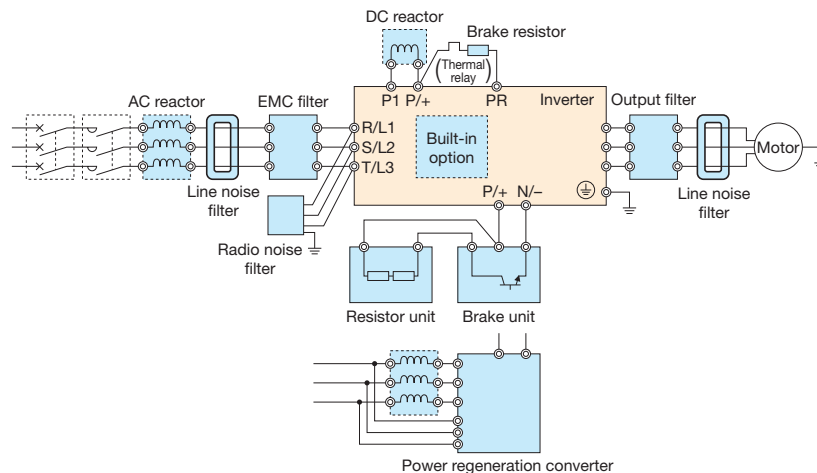

# List of options

○: Available x: Not available

Name	Model	Applicable inverter								
		FR-A800	FR-F800	FR-E700	FR-F700PJ	FR-D700	FR-V500(L)	FR-A701		
Plug-in option (control function expansion, additional input/output)										
Orientation control	FR-A8AP	○	x	x	x	x	x	x		
Encoder feedback control	FR-A7AP	x	x	x	x	x	Vector control/orientation control are available as standard	○		
Vector control										
Orientation control/encoder feedback control vector control/position control/encoder pulse dividing output	FR-A7AL	x	x	x	x	x	x	○		
Orientation control	FR-A5AP	x	x	x	x	x	○	x		
Pulse train input										
Machine end orientation	FR-V5AM	x	x	x	x	x	○	x		
Position control	FR-V5AP	x	x	x	x	x	○	x		
12 V control circuit terminal block with encoder power supply	FR-A7PS	x	x	x	x	x	x	○		
16-bit digital input	FR-ABAX	○	○	x	x	x	x	x		
	FR-A7AX	x	x	E-kit compatible	x	x	x	○		
	FR-V5AH	x	x	x	x	x	○	x		
12-bit digital input	FR-A5AX	x	x	x	x	x	○	x		
	FR-ABAY	○	○	x	x	x	x	x		
Analog output (2 terminals)	FR-A7AY	x	x	E-kit compatible	x	x	x	○		
	FR-A5AY	x	x	x	x	x	○	x		
Digital output (7 terminals)	FR-ABAR	○	○	x	x	x	x	x		
	FR-A7AR	x	x	E-kit compatible	x	x	x	○		
Relay output (3 terminals)	FR-A5AR	x	x	x	x	x	○	x		
	FR-ASNR	x	x	x	x	x	○	x		
Relay output (1 terminal) (RS-485 communication)										
Coded analog output	FR-A7AZ	x	x	x	x	x	x	○		
High-resolution analog input										
Motor thermistor interface										
24 VDC input	FR-E7DS	x	x	Compatible only with E700-SC	x	x	x	x		
Extra contact input (6 terminals)	FR-V5AX	x	x	x	x	x	○	x		
High-resolution analog input										
Motor thermistor interface										
Additional open collector output	FR-V5AY	x	x	x	x	x	○	x		
Encoder pulse division output										
Trace card	T-TRC50	x	x	x	x	x	○	x		
Plug-in option (communication support)										
RS-485	PU connector (main body)	Standard	Standard	Standard <sup>*1</sup>	Standard	Standard	Standard	Standard		
	Dedicated terminal block (main body)	Standard	Standard	x	x	x	x	Standard		
	FR-ASNR	x	x	x	x	x	○	x		
USB	USB device	FR-E7TR	x	x	Only the standard models are compatible	x	x	○	x	
		A connector	Standard	Standard	x	x	x	x	x	
		B connector	x	x	x	x	x	x	Standard	
CC-Link	USB host	Mini B connector	Standard	Standard	Standard	x	x	x	x	
		FR-ABNC	○	○	x	x	x	x	x	
		FR-A7NC	x	x	E-kit compatible	x	x	x	○	
2	OC-Link IE Field Network	FR-ASNC	x	x	x	x	x	○	x	
		Dedicated model	x	x	E700-NC	x	x	x	x	
		FR-ABNCE	○	○	x	x	x	x	x	
LonWorks®	DeviceNet™	FR-A7NL	x	x	E-kit compatible	x	x	x	○	
		FR-ABND	○	○	x	x	x	x	x	
		FR-A7ND	x	x	E-kit compatible	x	x	x	○	
PROFIBUS-DP	Modbus Plus	FR-ASND	x	x	x	x	x	○	x	
		FR-ABNP	○	○	x	x	x	x	x	
		FR-A7NP	x	x	E-kit compatible	x	x	x	○	
Ethernet	FL remote	FR-ASNPA	x	x	x	x	x	○	x	
		FR-ASNM	x	x	x	x	x	Compatible only with V500L	x	
		FR-V5NE	x	x	x	x	x	Compatible only with V500	x	
SSCNET III	SSCNET	Dedicated model	x	x	E700-NF	x	x	x	x	
		FR-V5NS	x	x	x	x	x	○	x	
		FR-A7NS	x	x	x	x	x	x	○	
Dedicated cable option										
3	Encoder cable	FR-V7CBL□□	○	x	x	x	x	x	○	
		FR-V5CBL□□	x	x	x	x	x	○	x	
		FR-JCBL□□	x	x	x	x	x	○	○	
USB cable	SSCNET cable	MR-J3USCBL3M	○	○	○	x	x	x	x	
		FR-V5NSCBL□□	x	x	x	x	x	x	x	
		SSCNET III cable	MR-J3BUS□M-□	x	x	x	x	x	x	○
Operation option										
4	Parameter unit	FR-PU07	○	○	○ <sup>*1</sup>	○	○	x	○	
		FR-PU07BB	○	○	○ <sup>*1</sup>	x	x	x	x	
		FR-PU04	x	x	○ <sup>*1</sup>	○	○	x	○	
		FR-PU04V	x	x	x	x	x	○	x	
LCD operation panel	Enclosure surface operation panel	FR-LU08	○	○	x	x	x	x	x	
		FR-PA07	x	x	○	○	○	x	x	
		FR-CB20□	○	○	○	○	○	○	○	
		FR-ADP	○	○	x	x	x	x	○	
Software										
5	FR Configurator	SW1DND-FRC2-□	○	○	x	x	x	x	x	
		FR-SW3-SETUP-W□	x	x	○ <sup>*11</sup>	○	○	x	○	
		FR-SW1-SETUP-W□	x	x	x	x	x	○	x	
Reactor										
6	AC reactor	FR-HAL	○	○	○	○	○	○	x	
		FR-HEL	○	○	○	○	○	○ <sup>*2</sup>	x	
Braking option										
7	Brake resistor	MRS, MYS	x	x	○ <sup>*3</sup>	○ <sup>*3</sup>	○ <sup>*3</sup>	x	x	
		High-duty brake resistor	FR-ABR	○ <sup>*3</sup>	x	○ <sup>*3</sup>	○ <sup>*3</sup>	○ <sup>*3</sup>	○ <sup>*3</sup>	x
		Resistor unit	FR-BU2	○ <sup>*4</sup>	○ <sup>*4</sup>	○ <sup>*4</sup>	○ <sup>*4</sup>	○ <sup>*4</sup>	○ <sup>*4</sup>	x
			Resistor	GRZG	○	○	○	○	○	x
			FR-BR	○	○	○	○	○	○	x
		Power regeneration common converter	MT-BR5	○	○	x	x	x	x	x
			FR-CV	○	○	○	○	○	○	x
Power regeneration converter	Dedicated standalone reactor	FR-CVL	○	○	○	○	○	x		
	FR-RC	○	○	○	○	○	○	x		
High power factor converter	MT-RC	○	○	x	x	x	○	x		
	FR-HC2	○	○	○	○	○	○	x		

Name	Model	Applicable inverter						
		FR-A800	FR-F800	FR-E700	FR-F700PJ	FR-D700	FR-V500(L)	FR-A701
<b>Noise filter</b>								
Radio noise filter	FR-BIF	Equivalent part built-in	Equivalent part built-in	○	○	○	○	○
Line noise filter	FR-BSF01	○ *5	○ *5	○	○	○	○	○
	FR-BLF	○ *5	○ *5	○	○	○	○	○
EMC Directive compliant noise filter	Built-in filter	Standard (2nd Environment)		x	x	x	x	x
	SF□□	x	x	○	x	○	○	○
	FR-E5NF	x	x	○	○	○	x	x
	FR-S5NFSA	x	x	○	x	○	x	x
Filterpack (DC reactor and noise filter)	FR-BFP2	x	x	○	○ *6	○	x	x
<b>Output filter</b>								
Surge voltage suppression filter	FR-ASF	○ *7	○ *7	○	○ *9	○	x	○ *7
	FR-BMF	○ *7	○ *7	○	○ *9	○	x	○ *7
Sine wave filter	Reactor	○ *8	○ *8	x	x	x	x	x
	Capacitor	○ *8	○ *8	x	x	x	x	x
<b>Structure option</b>								
Heatsink protrusion attachment	FR-A8CN	○	○	x	x	x	x	x
	FR-A5CN	x	x	x	x	x	○	x
	MT-A5CN	x	x	x	x	x	○	x
	FR-E7CN	x	x	○	○	○	x	x
Totally enclosed structure specification attachment	FR-A5CV	x	x	x	x	x	○	x
	FR-E7CV	x	x	○ *12	x	x	x	x
Attachment for conduit connection	FR-A5FN	x	x	x	x	x	○	x
Control circuit terminal block intercompatibility attachment	FR-A8TAT	○	○	x	x	x	x	x
	FR-AAT	○	○	○	○	○	x	x
Intercompatibility attachment	FR-A5AT	○	○	○	○	○	○	x
	FR-E7AT	x	x	○	x	x	x	x
	FR-F8AT	x	○	x	x	x	x	x
	FR-F8AT	x	○	x	x	x	x	x
EMC filter mounting attachment	FR-EST	x	x	○	○	○	x	x
DIN rail mounting attachment	FR-UDA	x	x	○ *10	○ *10	○ *10	x	x
<b>FR Series controller and setter</b>								
Manual controller with frequency meter	FR-AX	○	○	○	○	○	○	○
DC tach. follower	FR-AL	○	○	○	○	○	○	○
Three speed selector	FR-AT	○	○	○	○	○	○	○
Remote speed setter	FR-FK	○	○	○	○	○	○	○
Ratio setter	FR-FH	○	○	○	○	○	○	○
Speed detector	FR-FP	○	○	○	○	○	○	○
Master controller	FR-FG	○	○	○	○	○	○	○
Soft starter	FR-FC	○	○	○	○	○	○	○
Deviation detector	FR-FD	○	○	○	○	○	○	○
Preamplifier	FR-FA	○	○	○	○	○	○	○
<b>Parts and others</b>								
Pilot generator	QVAH-10	○	○	○	○	○	○	○
Deviation sensor	YVGC-500W-NS	○	○	○	○	○	○	○
Frequency setting potentiometer, Meter, Potentiometer	WA2W 1kΩ	○	○	○	○	○	○	○
Frequency meter	YM206NRI 1 mA	○	○	○	○	○	x	○
Calibration resistor	RV24YN 10kΩ	○	○	○	○	○	x	○

\*1: PU connector is disabled for the FL remote communication model and the CC-Link communication model.

\*2: The DC reactor is equipped as standard with the 75K or higher capacities.

\*3: Only compatible with models which have a built-in brake transistor.

\*4: The 200 V class 0.2K or lower, 400 V class 1.5K or lower cannot be used with the brake unit.

\*5: An equivalent part (common mode choke) is built into the input side of 55K or lower capacities.

\*6: Filterpack (FR-BFP2) is enclosed for the inverter with Filterpack

("F" is marked at the end of its model name on the packaging box).

\*7: The filter can be used under V/F control or Advanced magnetic flux vector control.

\*8: The filter can be used under V/F control.

\*9: Not available under IPM motor control.

\*10: Compatible with 3.7 kW or lower capacities.

\*11: FR Configurator is not compatible with FL remote communication models.

\*12: The FR-E7CV can be used only with the FR-E720-0.1K to 7.5K.



## Power regeneration common converter

# FR-CV

- Continuous regenerative operation at 100 % torque is possible with this converter. It is useful for lift operation and line control. (Regeneration at a max. 150% torque for 60 s is possible.)
- This converter is a common converter. Each inverter does not need a brake unit when this converter is used. Use this converter to cut down the total space and the cost.

Voltage	Applicable inverter capacity	Main body	Dedicated stand-alone reactor	Voltage	Applicable inverter capacity	Main body	Dedicated stand-alone reactor
200 V	7.5K	FR-CV-7.5K(-AT)	FR-CVL-7.5K	400 V	7.5K	FR-CV-H7.5K(-AT)	FR-CVL-H7.5K
	11K	FR-CV-11K(-AT)	FR-CVL-11K		11K	FR-CV-H11K(-AT)	FR-CVL-H11K
	15K	FR-CV-15K(-AT)	FR-CVL-15K		15K	FR-CV-H15K(-AT)	FR-CVL-H15K
	22K	FR-CV-22K(-AT)	FR-CVL-22K		22K	FR-CV-H22K(-AT)	FR-CVL-H22K
	30K	FR-CV-30K(-AT)	FR-CVL-30K		30K	FR-CV-H30K(-AT)	FR-CVL-H30K
	37K	FR-CV-37K	FR-CVL-37K		37K	FR-CV-H37K	FR-CVL-H37K
	55K	FR-CV-55K	FR-CVL-55K		55K	FR-CV-H55K	FR-CVL-H55K

\* Dedicated stand-alone reactor is an option.

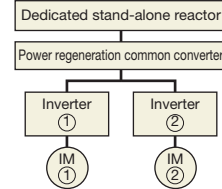

## High power factor converter

# FR-HC2

- Harmonic current is greatly suppressed, and the equivalent capacity conversion coefficient  $K5=0$  in the "Japanese specific consumer higher harmonics suppression guidelines" is achieved.
- Input current waveforms are improved to be sine waves.
- Power regeneration function is provided as standard.

Voltage class	High power factor converter	Voltage class	High power factor converter	Standard accessories
200 V class	FR-HC2-7.5K	400 V class	FR-HC2-H7.5K	Reactor 1, reactor 2, external box* (Use in combination with the above accessories. The wires for connecting the standard accessories are not included.)
	FR-HC2-15K		FR-HC2-H15K	
	FR-HC2-30K		FR-HC2-H30K	
	FR-HC2-55K		FR-HC2-H55K	
	FR-HC2-75K		FR-HC2-H75K	
			FR-HC2-H110K	
			FR-HC2-H160K	
			FR-HC2-H220K	
			FR-HC2-H280K	
			FR-HC2-H400K	
			FR-HC2-H560K	

\* Peripheral devices are separately provided for FR-HC2-H280K or higher (not provided in a box).



## Brake unit

# FR-BU2

- The regenerative power from the motor is consumed as heat to improve the braking capacity of the motor.
- Connect this unit to the DC bus voltage directly to use with the conventional inverter.
- This unit can replace conventional models, BU, FR-BU, and MT-BU5.
- The units can be connected in parallel to handle large capacity.

Voltage class	Brake unit model	Voltage class	Brake unit model
200 V class*	FR-BU2-1.5K	400 V class*	FR-BU2-H7.5K
	FR-BU2-3.7K		FR-BU2-H15K
	FR-BU2-7.5K		FR-BU2-H30K
	FR-BU2-15K		FR-BU2-H55K
	FR-BU2-30K		FR-BU2-H75K
	FR-BU2-55K		FR-BU2-H220K
			FR-BU2-H280K

\* Resistors and resistor units are required. Refer to the Instruction Manual for the combination patterns.



# Mitsubishi Product Guide

High-performance energy-saving motor

## SF-PR

We have released the superline premium series SF-PR models compatible with IE3 premium efficiency ahead of the three-phase motor energy efficiency regulations in Japan.

The SF-PR has achieved the efficiency class IE3 with the same dimensions as those of conventional models using our unique technology of the steel plate frame and new core materials.

It maintains interchangeability with our standard motor SF-JR and easy replacement becomes possible. By adopting a high-efficiency motor, energy savings in plant facilities and reduction of electricity consumption are expected, as well as the effects of recovering the investment cost.



### One motor conforms to the power supply in Japan and the United States.

- The SF-PR series conform to the Top Runner Standard of the "Act on the Rational Use of Energy (energy saving law)" to be applied on April 1, 2015.
- The 230 V 60 Hz motors of the series also conform to the Energy Independence and Security Act (EISA).

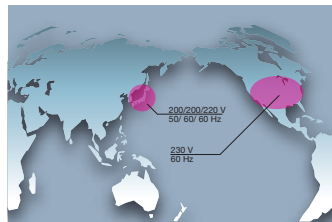

200	200	220	230	V
50	60	60	60	Hz

In Japan In the United States

\*For the 200 V class

### Interchangeable installation size

- Replacement can be smoothly performed because the installation size (frame number) is compatible with our standard motor SF-JR series.
- It is possible to use a power distribution control equipment (thermal relay and breaker), which is the same as a conventional one.

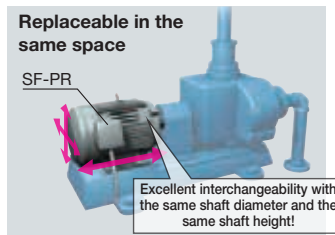

\*1 For the frame number 180 LD or higher and some models of the 6P product, the total length or diametrical dimension is greatly different.  
 \*2 The frame number is different from 1.5 kW6P (112M), 2.2 kW6P(132S) of the SF-JR models.  
 \*3 When replacing the SF-JR to the SF-PR, it is required to consider upgrading the contactor to secure the same electric durability as using the SF-JR because the electric durability of the contactor may reduce by about 30%. Besides, when replacing the SF-JR to the SF-PR, the existing thermal relay may trip depending on the operating conditions (long starting time). As a countermeasure, consider "Adjusting the heater set value of the thermal" or "Adopting the thermal with a saturated reactor", etc.  
 \*4 If the breaker NF400-SW manufactured by Mitsubishi Electric is used with the 55 kW motor (Y-Δ starting), change the breaker. (Change the rated current of the breaker NF400-SW from 300 A to 350 A.)

### Introduction effects of the superline premium series SF-PR

The SF-PR motor conforms to the Top Runner Standard (IE3 equivalent), which remarkably reduces its operation cost (electricity charges) and greatly contributes minimization of TCO (Total Cost Ownership).

- Trial calculation example of an annual saved sum of money (at upgrading the motor from energy-efficiency class IE1 to IE3)  
 Motor with 4-poles 200 V 50 Hz

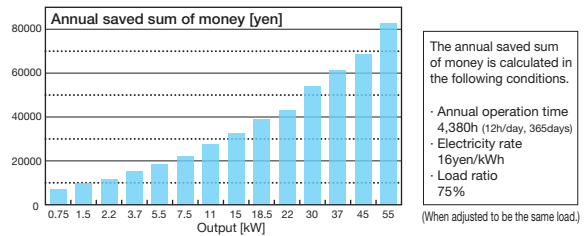

The annual saved sum of money is calculated in the following conditions.  
 · Annual operation time 4,380h (12h/day, 365days)  
 · Electricity rate 16yen/kWh  
 · Load ratio 75%

### Economic efficiency on an energy saving effect

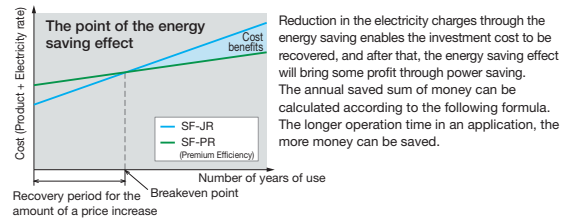

#### <Calculation formula>

$$\text{Output (kW)} \times \left( \frac{100}{\text{Efficiency of current motor (\%)}} - \frac{100}{\text{Efficiency of SF-PR model (\%)}} \right) \times \text{Number of motors} \times \text{Number of hours of use (h/day)} \times \text{Number of days of operation (day/year)} \times \text{Electricity rate (yen/kWh)}$$

When replacing our standard motor SF-JR with the SF-PR on the ventilation fan in plant

<Condition>  
 Type : 11 kW 4P 200 V 50 Hz 75% load  
 Units : 10units  
 Operation time : 12h/day 365day/year  
 Electricity rate: 16yen/kWh

**Reduced cost of about 350,000 yen per year**

Trial calculation results in replacing the SF-JR with the SF-PR with improved efficiency by 5% under the same conditions of the load factor, operation time, and electricity charges, etc.

## Lineup

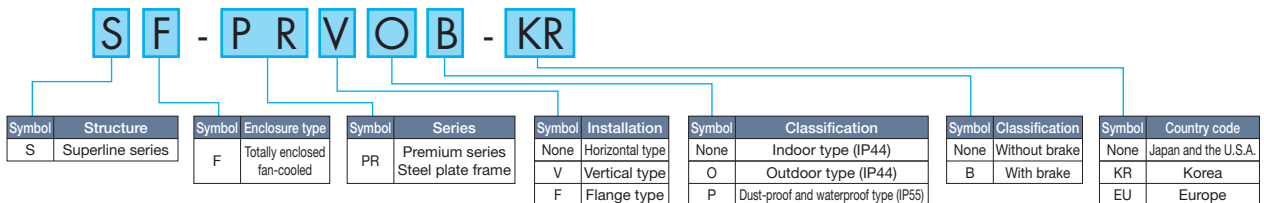

### Available range

Type	Totally enclosed fan-cooled															
	Foot mounting type			Vertical type			Flange type			Outdoor type			Dust-proof and waterproof type			
	SF-PR			SF-PRV			SF-PRF			SF-PRO			SF-PRP			
Model	2P	4P	6P	2P	4P	6P	2P	4P	6P	2P	4P	6P	2P	4P	6P	
Number of poles	0.75	1.5	2.2	3.7	5.5	7.5	11	15	18.5	22	30	37	45	55		
Output [kW]	●	●	●	●	●	●	●	●	●	●	●	●	●	●	●	●

· The vertical type and the flange type are also available for the outdoor type and the dustproof/waterproof type.  
 · SF-THE3 is used for the frame number of 250 or higher.

●: Available range

# WS-V Series

"WS-V Series" is the new circuit breakers that have a lot of superior aspects such as higher breaking capacity, design for easy use, standardization of accessory parts, and compliance to the global standards.

## Features

### Technologies based on long years of experience are brought together to achieve improved performance

The new circuit breaking technology "Expanded ISTAC" has improved the currentlimiting performance and upgraded the overall breaking capacity.

Expansion of the conductor under the stator shortens the contact parting time of the mover as compared to the conventional ISTAC structure.

The current-limiting performance has been improved remarkably. (The maximum peak current value has been reduced by approx. 10%.)

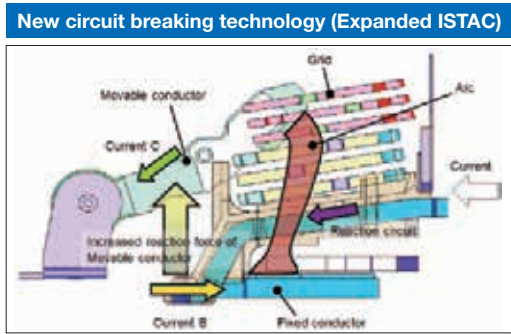

Breaking capacity comparison with a conventional model

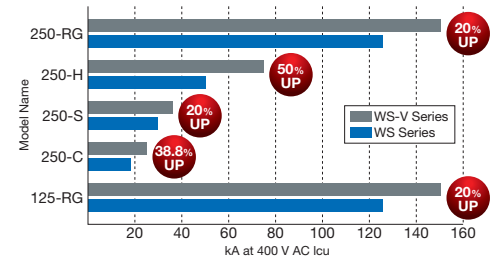

### Compact design for ease of use

The thermal adjustable circuit breakers and electronic circuit breakers are smaller.

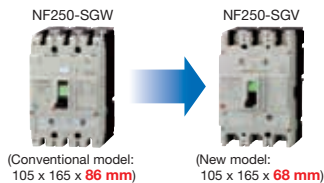

**Volume ratio 79%**  
(Compared with our conventional models)



### Types of internal accessories are reduced from 3 types to 1 type

Standardization of internal accessories contributes to a reduction of stock and delivery time.

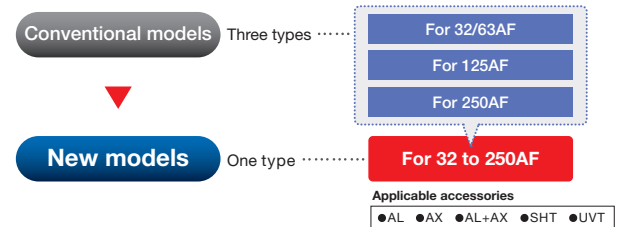

### Lineup of UL 489 listed circuit breakers with 54 mm width "Small Fit" F Style

The compact breakers contribute to a size reduction of machines, and IEC 35 mm rail mounting is standard.



For security and standard compliance of machines, F-type and V-type operating handles are available for breakers with 54 mm width.

### Lineup of UL 489 listed circuit breakers for 480 V AC "High Performance"

The breaking capacity has been improved to satisfy the request for SCCR upgrading.

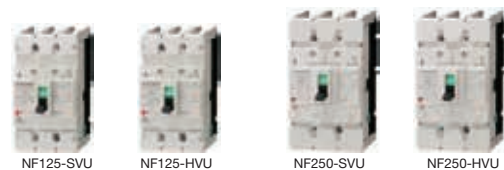

Breaking capacity of UL 489 listed circuit breakers for 480 V AC (UL 489)

NF125-SVU/NV125-SVU	30 kA
NF125-HVU/NV125-HVU	50 kA
NF250-SVU/NV250-SVU	35 kA
NF250-HVU/NV250-HVU	50 kA

## Mitsubishi Magnetic Motor Starters and Magnetic Contactors

# MS-T Series

MS-T series is newly released!

The MS-T series is smaller than ever, enabling more compact control panel. The MS-T series is suitable for other Mitsubishi FA equipment. In addition, the MS-T conforms to a variety of global standards, supporting the global use.

## Features

### Compact

Just 36 mm wide for 10 A-frame type!

General-purpose magnetic contactor with smallest width\*1 in the industry. The width of MS-T series is reduced by 32% as compared to the prior MS-N series, enabling a more compact panel.

\*1: Based on Mitsubishi Electric research as of October 2013 in the general-purpose magnetic contactor industry for 10 A-frame class.



[Unit: mm]

Frame size		11 A	13 A		20 A	25 A
MS-N series	Front view	43  S-N10	43  S-N11 (Auxiliary 1-pole)	53  S-N12 (Auxiliary 2-pole)	63  S-N20	75  S-N25
		New MS-T series	Front view	36  S-T10 <b>-7mm!</b>	43  S-T12 (Auxiliary 2-pole) <b>-10mm!</b>	43  S-T20 <b>-20mm!</b>

### Standardization

- Covers provided as standard equipment

Terminal cover and auxiliary contact unit covers are provided as standard equipment. Not only ensuring your safety, but also saving you time and cost of selecting and purchasing the covers separately.

- Wide-ranged operation coil rating

The prior series had 14 types of the operation coil rating. Owing to the wideranged operation coil rating, the number of the rating types for the MS-T series is reduced to half, making it easier to select as compared to the prior model. Consolidating the number of the produced coils type allows not just the reduction of customer storage, but also shortening of delivery time.

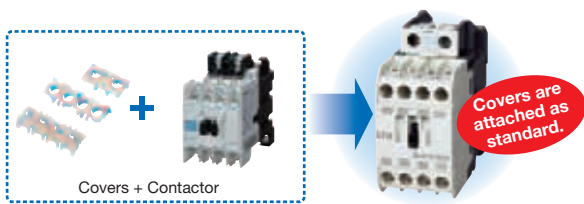

Coil designation	Rated voltage [V]	
	50 Hz	60 Hz
AC12 V	12	12
AC24 V	24	24
AC48 V	48 to 50	48 to 50
AC100 V	100	100 to 110
AC120 V	110 to 120	115 to 120
AC127 V	125 to 127	127
AC200 V	200	200 to 220
AC220 V	208 to 220	220
AC230 V	220 to 240	230 to 240
AC260 V	240 to 260	260 to 280
AC380 V	346 to 380	380
AC400 V	380 to 415	400 to 440
AC440 V	415 to 440	460 to 480
AC500 V	500	500 to 550

Coil designation	Rated voltage [V]	
	50 Hz	60 Hz
AC24 V	24	
AC48 V	48 to 50	
AC100 V	100 to 127	
AC200 V	200 to 240	
AC300 V	260 to 300	
AC400 V	380 to 440	
AC500 V	460 to 550	

(12 V type is an order-made product.)

### Global Standard

- Conforms to various global standards

Not only major global standards such as IEC, JIS, UL, CE, and CCC but also ship standards and other country standards are planned to be certified.

- Conforms to various global standards

Standard	Applicable Standard				Safety Standard
	International	Japan	Europe	China	U.S.A. and Canada
	IEC <sup>*1</sup>	JIS	EN EC Directive	Certification Body	GB

\*1: The MS-T series also provide safe isolation (mirror contact) specified in the IEC standard.

\*2: The motor starters are certified under each type name of the magnetic contactors and the thermal overload relays on the condition that the magnetic contactors and the thermal overload relays are used in combination.

# MS-N Series

Environment-friendly Mitsubishi MS-N series ensures safety and conforms to various global standards. Its compact size contributes to space-saving in a machine. The MS-N series is suitable for other Mitsubishi FA equipment and can be used globally.

## Features

### ■Bifurcated contact adopted to achieve high contact reliability

Contact reliability is greatly improved by combining bifurcated moving contact and stationary contact.

This series responds to the various needs such as the application to safety circuit. (The MS-T series also has bifurcated contacts.)

### ■Mirror contact (auxiliary contact off at main contact welding)

The MS-N series meets requirements of "Control functions in the event of failure" described in EN 60204-1 "Electrical equipment of machines", being suitable as interlock circuit contact. The MS-N series is applicable for category 4 safety circuit. We ensure safety for our customers. (The MS-T series also has mirror contacts.)

### ■Various option unit

Various options including surge absorbers and additional auxiliary contact blocks are available.

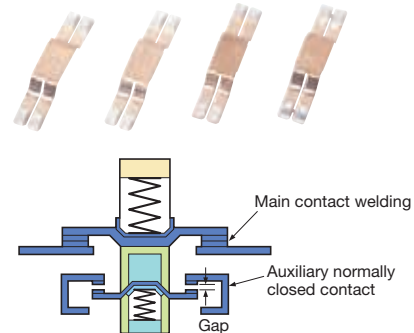
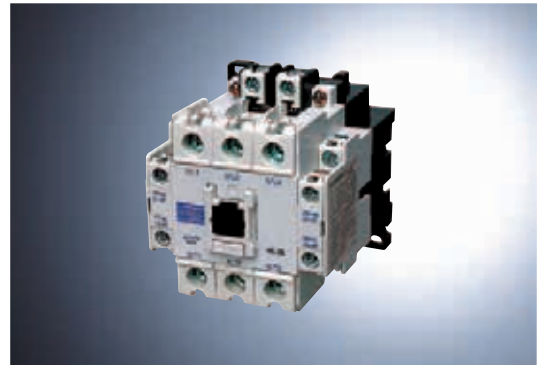

- Conforms to various global standards

◎: Compliant as standard

Model	Applicable Standard				Safety Standard		EC Directive	Certification Body	CCC
	IEC International	JIS Japan	DIN/VDE Germany	BS/EN England/Europe	UL U.S.A	CSA Canada	CE Marking Europe	TÜV Germany	GB China
S-N10 to S-N400 MSO-N10 to MSO-N400 TH-N12KP to TH-N400KP	◎	◎	◎	◎	◎	◎	◎	◎	◎

# EcoMonitorLight

The handy, low cost energy measuring module with an integrated display visualizes energy consumption.

## Features

### ■Measurement and display of the energy consumption in a single module

With the built-in LCD display, the single module enables measurement and display of the energy consumption. The module can be used for simple measurement of the production equipment (motors, compressors, etc.) and verification of the energy saving effect by measuring the energy consumption before and after introduction of high-efficiency equipment (inverters, etc.).

### ■System coordination facilitated by the standard MODBUS® RTU communication function

The MODBUS® RTU communication is supported as standard, facilitating coordination with the host system (programmable controller, GOT, etc.).

For example, by using GOT to visualize the energy consumption at work sites, you can raise the awareness of energy saving, and achieve the energy management in response to the actual operation of the production equipment.

\* The GOT sample screen data can be downloaded free of charge from the Mitsubishi Electric FA Global Website.

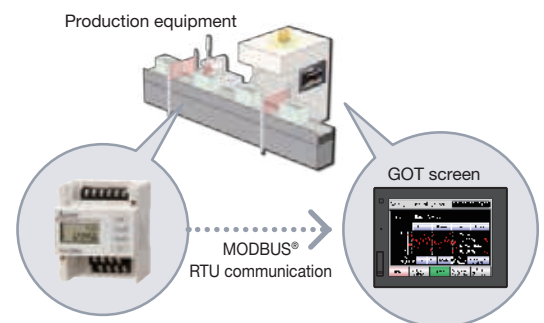

Energy measuring module in the enclosure  
Energy information is transmitted to GOT using MODBUS® RTU communication.

## Molded case circuit breaker, magnetic contactor, cable gauge (FR-A800)

### •280K or lower

Voltage	Motor output (kW) <sup>①</sup>	Applicable inverter model (ND rating)	Molded case circuit breaker (MCCB) <sup>②</sup> or earth leakage circuit breaker (ELB) (NF, NV type)		Input side magnetic contactor <sup>③</sup>		Recommended Cable gauge (mm <sup>2</sup> ) <sup>④</sup>	
			Power factor improving (AC or DC) reactor connection		Power factor improving (AC or DC) reactor connection		R/L1, S/L2, T/L3	U, V, W
			Without	With	Without	With		
200 V class	0.4	FR-A820-00046 (0.4K)	5 A	5 A	S-T10	S-T10	2	2
	0.75	FR-A820-00077 (0.75K)	10 A	10 A	S-T10	S-T10	2	2
	1.5	FR-A820-00105 (1.5K)	15 A	15 A	S-T10	S-T10	2	2
	2.2	FR-A820-00167 (2.2K)	20 A	15 A	S-T10	S-T10	2	2
	3.7	FR-A820-00250 (3.7K)	30 A	30 A	S-T21	S-T10	3.5	3.5
	5.5	FR-A820-00340 (5.5K)	50 A	40 A	S-N25	S-T21	5.5	5.5
	7.5	FR-A820-00490 (7.5K)	60 A	50 A	S-N25	S-N25	14	8
	11	FR-A820-00630 (11K)	75 A	75 A	S-N35	S-N35	14	14
	15	FR-A820-00770 (15K)	125 A	100 A	S-N50	S-N50	22	22
	18.5	FR-A820-00930 (18.5K)	150 A	125 A	S-N65	S-N50	38	38
	22	FR-A820-01250 (22K)	175 A	150 A	S-N80	S-N65	38	38
	30	FR-A820-01540 (30K)	225 A	175 A	S-N95	S-N80	60	60
	37	FR-A820-01870 (37K)	250 A	225 A	S-N150	S-N125	80	80
	45	FR-A820-02330 (45K)	300 A	300 A	S-N180	S-N150	100	100
	55	FR-A820-03160 (55K)	400 A	350 A	S-N220	S-N180	100	100
75	FR-A820-03800 (75K)	—	400 A	—	S-N300	125	125	
90	FR-A820-04750 (90K)	—	400 A	—	S-N300	150	150	
400 V class	0.4	FR-A840-00023 (0.4K)	5 A	5 A	S-T10	S-T10	2	2
	0.75	FR-A840-00038 (0.75K)	5 A	5 A	S-T10	S-T10	2	2
	1.5	FR-A840-00052 (1.5K)	10 A	10 A	S-T10	S-T10	2	2
	2.2	FR-A840-00083 (2.2K)	10 A	10 A	S-T10	S-T10	2	2
	3.7	FR-A840-00126 (3.7K)	20 A	15 A	S-T10	S-T10	2	2
	5.5	FR-A840-00170 (5.5K)	30 A	20 A	S-T21	S-T12	2	2
	7.5	FR-A840-00250 (7.5K)	30 A	30 A	S-T21	S-T21	3.5	3.5
	11	FR-A840-00310 (11K)	50 A	40 A	S-T21	S-T21	5.5	5.5
	15	FR-A840-00380 (15K)	60 A	50 A	S-N25	S-T21	8	8
	18.5	FR-A840-00470 (18.5K)	75 A	60 A	S-N25	S-N25	14	8
	22	FR-A840-00620 (22K)	100 A	75 A	S-N35	S-N25	14	14
	30	FR-A840-00770 (30K)	125 A	100 A	S-N50	S-N50	22	22
	37	FR-A840-00930 (37K)	150 A	125 A	S-N65	S-N50	22	22
	45	FR-A840-01160 (45K)	175 A	150 A	S-N80	S-N65	38	38
	55	FR-A840-01800 (55K)	200 A	175 A	S-N80	S-N80	60	60
	75	FR-A840-02160 (75K)	—	225 A	—	S-N95	60	60
	90	FR-A840-02600 (90K)	—	225 A	—	S-N150	60	60
	110	FR-A840-03250 (110K)	—	225 A	—	S-N180	80	80
132	FR-A840-03610 (132K)	—	400 A	—	S-N220	100	100	
150	FR-A840-04320 (160K)	—	400 A	—	S-N300	125	150	
160	FR-A840-04320 (160K)	—	400 A	—	S-N300	125	150	
185	FR-A840-04810 (185K)	—	400 A	—	S-N300	150	150	
220	FR-A840-05470 (220K)	—	500 A	—	S-N400	2×100	2×100	
250	FR-A840-06100 (250K)	—	600 A	—	S-N600	2×100	2×100	
280	FR-A840-06830 (280K)	—	600 A	—	S-N600	2×125	2×125	

\*1: Assumes the use of an IPM motor MM-CF or a Mitsubishi 4-pole standard motor with the motor capacity of 200 VAC 50 Hz.

\*2: Select an MCCB according to the power supply capacity.  
Install one MCCB per inverter.

For the use in the United States or Canada, provide the appropriate UL and cUL listed fuse or UL489 molded case circuit breaker (MCCB) that is suitable for branch circuit protection. (Refer to the Instruction Manual (Detailed).)

\*3: The magnetic contactor is selected based on the AC-1 class. The electrical durability of magnetic contactor is 500,000 times. When the magnetic contactor is used for emergency stops during motor driving, the electrical durability is 25 times.  
If using an MC for emergency stop during motor driving or using it on the motor side during commercial power supply operation, select an MC with the class AC-3 rated current for the rated motor current.

\*4: Cables

For FR-A820-03160(55K) or lower and FR-A840-01800(55K) or lower, it is the gauge of a cable with the continuous maximum permissible temperature of 75°C. (HIV cable (600 V grade heat-resistant PVC insulated wire), etc.) It assumes a surrounding air temperature of 50°C or lower and the wiring distance of 20 m or shorter.

For FR-A820-03800(75K) or higher and FR-A840-02160(75K) or higher, it is the gauge of the cable with the continuous maximum permissible temperature of 90°C or higher. (LMFC (heat resistant flexible cross-linked polyethylene insulated cable), etc.) It assumes a surrounding air temperature of 50°C or lower and in-enclosure wiring.

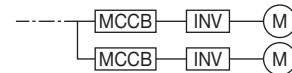

#### NOTE

- When the inverter capacity is larger than the motor capacity, select an MCCB and a magnetic contactor according to the inverter model, and select cables and reactors according to the motor output.
- When the breaker on the inverter's input side trips, check for the wiring fault (short circuit), damage to internal parts of the inverter etc. The cause of the trip must be identified and removed before turning ON the power of the breaker.

•315K or higher

Voltage	Motor output (kW) <sup>*1</sup>	Applicable inverter model (ND rating)	Applicable converter model	Molded case circuit breaker (MCCB) <sup>*2</sup> or earth leakage circuit breaker (ELB) (NF, NV type)	Input-side magnetic contactor <sup>*3</sup>	HIV cables, etc. (mm <sup>2</sup> ) <sup>*4</sup>		
						R/L1, S/L2, T/L3	P/+, N/-	U, V, W
400 V class	315	FR-A842-07700 (315K)	FR-CC2-H315K-60	700 A	S-N600	2 x 150	2 x 150	2 x 150
	355	FR-A842-08660 (355K)	FR-CC2-H355K-60	800 A	S-N600	2 x 200	2 x 200	2 x 200
	400	FR-A842-09620 (400K)	FR-CC2-H400K-60	900 A	S-N800	2 x 200	2 x 200	2 x 200
	450	FR-A842-10940 (450K)	FR-CC2-H450K-60	1000 A	1000 A rated product	2 x 250	2 x 250	2 x 250
	500	FR-A842-12120 (500K)	FR-CC2-H500K-60	1200 A	1000 A rated product	3 x 200	3 x 200	2 x 250

\*1: Assumes the use of a Mitsubishi 4-pole standard motor with the motor capacity of 400 VAC 50 Hz.

\*2: Select an MCCB according to the power supply capacity.  
Install one MCCB per converter.

For the use in the United States or Canada, provide the appropriate UL and cUL listed fuse that is suitable for branch circuit protection. (Refer to the Instruction Manual (Detailed) of the inverter.)

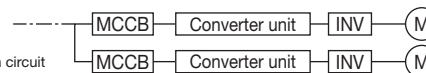

\*3: The magnetic contactor is selected based on the AC-1 class. The electrical durability of magnetic contactor is 500,000 times. When the magnetic contactor is used for emergency stops during motor driving, the electrical durability is 25 times.

If using an MC for emergency stop during driving the motor, select an MC regarding the converter unit input side current as JEM1038-AC-3 class rated current. When using an MC on the inverter output side for commercial-power supply operation switching using a general-purpose motor, select an MC regarding the rated motor current as JEM1038-AC-3 class rated current.

\*4: The gauge of the cable with the continuous maximum permissible temperature of 90°C or higher. (LMFC (heat resistant flexible cross-linked polyethylene insulated cable), etc.). It assumes a surrounding air temperature of 40°C or lower and in-enclosure wiring.

NOTE

- When the converter unit capacity is larger than the motor capacity, select an MCCB and a magnetic contactor according to the converter unit model, and select cables and reactors according to the motor output.
- When the breaker on the converter unit's input side trips, check for the wiring fault (short circuit), damage to internal parts of the inverter and the converter unit, etc. The cause of the trip must be identified and removed before turning ON the power of the breaker.

For the other series, refer to the catalog of each series.

## List of Alternative Models for the Conventional Series

Conventional series name	Production termination schedule	Repair components supply termination	Alternative model
FR-F2	December 1986	November 1993	FR-F800 FR-A800 <sup>*1</sup>
FR-K	December 1986	November 1993	FR-A800
FR-K400	July 1989	June 1996	FR-A800
FR-F300	July 1989	June 1996	FR-F800 FR-A800 <sup>*1</sup>
FR-K3	July 1989	June 1996	FR-A800
FR-E	September 1993	August 2000	FR-A800
FR-Z020	March 1994	March 2001	FR-E700 FR-D700
FR-Z300	June 1994	June 2001	FR-A800
FR-Z100	December 1994	December 2001	FR-A800
FR-Z123	March 1995	March 2002	FR-E700 FR-D700
FR-F400	June 1995	June 2002	FR-F800 FR-A800 <sup>*1</sup>
FR-A200	October 1995	October 2002	FR-A800
FR-Z024	October 1995	October 2002	FR-E700 FR-D700
FR-V200	April 1996	April 2003	FR-V500 FR-A800+FR-A8AP
FR-A100	April 1996	April 2003	FR-F800
FR-Z200	June 1996	April 2003	FR-A800
FR-A200E	April 2000	April 2007	FR-A800
MT-A100E	April 2000	April 2007	FR-F800
FR-A100E	September 2000	September 2007	FR-F800
MT-A200E	September 2000	September 2007	FR-A800
FR-U100	September 2001	September 2008	FR-D700
FR-S500 (3-phase 200 V)	June 2004	June 2011	FR-D700
FR-V200E	October 2004	October 2011	FR-V500 FR-A800+FR-A8AP
FR-S500 (3 phase 400 V/1-phase 200 V/1-phase 100 V)	May 2006	May 2013	FR-D700
FR-F500 (L)	May 2006	May 2013	FR-F800
FR-A500 (L)	April 2007	April 2014	FR-A800
FR-A024/A044	December 2008	December 2015	FR-E700 FR-D700
FR-A201E	September 2009	September 2016	FR-A701
FR-S500E	August 2010	August 2017	FR-D700
FR-E500	April 2011	April 2018	FR-E700
FR-F700	August 2011	August 2018	FR-F800
FR-FP700	August 2011	August 2018	FR-F800
FR-HC (200 V)	October 2011	October 2018	FR-HC2 (200 V)
MT-HC (200 V)	October 2011	October 2018	FR-HC2 (200 V)
MT-B	November 2011	November 2018	FR-B
FR-F500J	April 2012	April 2019	FR-F700PJ
FR-FP500J	April 2012	April 2019	FR-F700PJ
FR-C500	April 2012	April 2019	FR-E700 (Use the FR-E700-NC or the CC-Link option.)
FR-HC (400 V)	October 2012	October 2019	FR-HC2 (400 V)
MT-HC (400 V)	October 2012	October 2019	FR-HC2 (400 V)
SC-A	April 2015	April 2022	FR-D700
MD-AX520	September 2015	September 2022	FR-A800
FR-A700	December 2015	December 2022	FR-A800

\*1: For the operation where the inverter output current exceeds 120% of its rated current, select the FR-A800 series.



# Warranty

When using this product, make sure to understand the warranty described below.

## Warranty period and coverage

We will repair any failure or defect (hereinafter referred to as "failure") in our FA equipment (hereinafter referred to as the "Product") arisen during warranty period at no charge due to causes for which we are responsible through the distributor from which you purchased the Product or our service provider. However, we will charge the actual cost of dispatching our engineer for an on-site repair work on request by customer in Japan or overseas countries. We are not responsible for any on-site readjustment and/or trial run that may be required after a defective unit are repaired or replaced.

### [Term]

The term of warranty for Product is twelve months after your purchase or delivery of the Product to a place designated by you or eighteen months from the date of manufacture whichever comes first ("Warranty Period"). Warranty period for repaired Product cannot exceed beyond the original warranty period before any repair work.

### [Limitations]

- (1) You are requested to conduct an initial failure diagnosis by yourself, as a general rule. It can also be carried out by us or our service company upon your request and the actual cost will be charged.  
However, it will not be charged if we are responsible for the cause of the failure.
- (2) This limited warranty applies only when the condition, method, environment, etc. of use are in compliance with the terms and conditions and instructions that are set forth in the instruction manual and user manual for the Product and the caution label affixed to the Product.
- (3) Even during the term of warranty, the repair cost will be charged on you in the following cases;
  - 1) a failure caused by your improper storing or handling, carelessness or negligence, etc., and a failure caused by your hardware or software problem
  - 2) a failure caused by any alteration, etc. to the Product made on your side without our approval
  - 3) a failure which may be regarded as avoidable, if your equipment in which the Product is incorporated is equipped with a safety device required by applicable laws and has any function or structure considered to be indispensable according to a common sense in the industry
  - 4) a failure which may be regarded as avoidable if consumable parts designated in the instruction manual, etc. are duly maintained and replaced
  - 5) any replacement of consumable parts (condenser, cooling fan, etc.)
  - 6) a failure caused by external factors such as inevitable accidents, including without limitation fire and abnormal fluctuation of voltage, and acts of God, including without limitation earthquake, lightning and natural disasters
  - 7) a failure generated by an unforeseeable cause with a scientific technology that was not available at the time of the shipment of the Product from our company
  - 8) any other failures which we are not responsible for or which you acknowledge we are not responsible for

## Term of warranty after the stop of production

- (1) We may accept the repair at charge for another seven (7) years after the production of the product is discontinued. The announcement of the stop of production for each model can be seen in our Sales and Service, etc.
- (2) Please note that the Product (including its spare parts) cannot be ordered after its stop of production.

## Service in overseas

Our regional FA Center in overseas countries will accept the repair work of the Product; however, the terms and conditions of the repair work may differ depending on each FA Center. Please ask your local FA center for details.

## Exclusion of responsibility for compensation against loss of opportunity, secondary loss, etc.

Whether under or after the term of warranty, we assume no responsibility for any damages arisen from causes for which we are not responsible, any losses of opportunity and/or profit incurred by you due to a failure of the Product, any damages, secondary damages or compensation for accidents arisen under a specific circumstance that are foreseen or unforeseen by our company, any damages to products other than the Product, and also compensation for any replacement work, readjustment, start-up test run of local machines and the Product and any other operations conducted by you.

## Change of Product specifications

Specifications listed in our catalogs, manuals or technical documents may be changed without notice.

## Application and use of the Product

- (1) For the use of our product, its applications should be those that may not result in a serious damage even if any failure or malfunction occurs in product, and a backup or fail-safe function should operate on an external system to product when any failure or malfunction occurs.
- (2) Our product is designed and manufactured as a general purpose product for use at general industries.  
Therefore, applications substantially influential on the public interest for such as atomic power plants and other power plants of electric power companies, and also which require a special quality assurance system, including applications for railway companies and government or public offices are not recommended, and we assume no responsibility for any failure caused by these applications when used.  
In addition, applications which may be substantially influential to human lives or properties for such as airlines, medical treatments, railway service, incineration and fuel systems, man-operated material handling equipment, entertainment machines, safety machines, etc. are not recommended, and we assume no responsibility for any failure caused by these applications when used.  
We will review the acceptability of the abovementioned applications, if you agree not to require a specific quality for a specific application. Please contact us for consultation.

# We visualize our customers' factories to solve problems and troubles.

"Visualization" of production and energy achieves future factories that advance one step forward.

The integrated solution, e-F@ctory, is based on our consolidated know-how, which has been developed through our own experiences as a user of FA products. Our e-F@ctory provides total cost reduction ranging from development to production and maintenance to achieve optimized production. This solution makes it possible to save energy and to optimize production by "visualization" that links upstream information systems and production site information, thus solving various problems on production sites.

## Sharing information across production systems

### MES Interface

Information sharing is easy and inexpensive because communication gateways, such as personal computers, are not necessary to connect factory equipment to the Manufacturing Execution System (MES).

## Optimizing production from a TCO\* stand point

### iQ Platform

Factory automation components such as controllers, human-machine interfaces, engineering environments, and networks are all seamlessly integrated to reduce TCO across different stages, from development to production and maintenance.

\* TCO : Total Cost of Ownership



## Visualization of energy consumption

### e&eco-F@ctory

It is indispensable for today's factory to be energy conscious and efficient. The e-F@ctory solution enables management of specific energy consumption, which provides the visibility needed to improve productivity. Additionally, this solution takes the total life cycle into account, including factors such as "measurement and diagnosis", "countermeasures", and "operation and management". Backed by several successes and achievements, our know-how will support your energy saving efforts.



### Network

CC-Link Family, the open field network of the world standard, and SSCNET III/H, the servo network for achieving high-speed processing and enhancement of instruction synchronization, flexibly expanding the connectivity among equipment and devices in the e-F@ctory environment.

### iQ Platform-compatible equipment

The inter-multi-CPU high-speed base unit provides slots for arbitrarily connecting programmable controllers, motion controllers, on-line CNCs, and robot controllers. Data communication speed among devices is enhanced, and their compatibility is extremely improved.

### iQ Platform-compatible engineering environments

Design information is integrated and shared at stages from system design to programming, tests and startup, and operation and maintenance. In addition, programming software programs for programmable controllers, motion controllers, on-line CNCs, robots, inverters, and GOTs, which are separately provided in a conventional environment, can be integrated.



# e-Factory

Products for achieving e-F@ctory

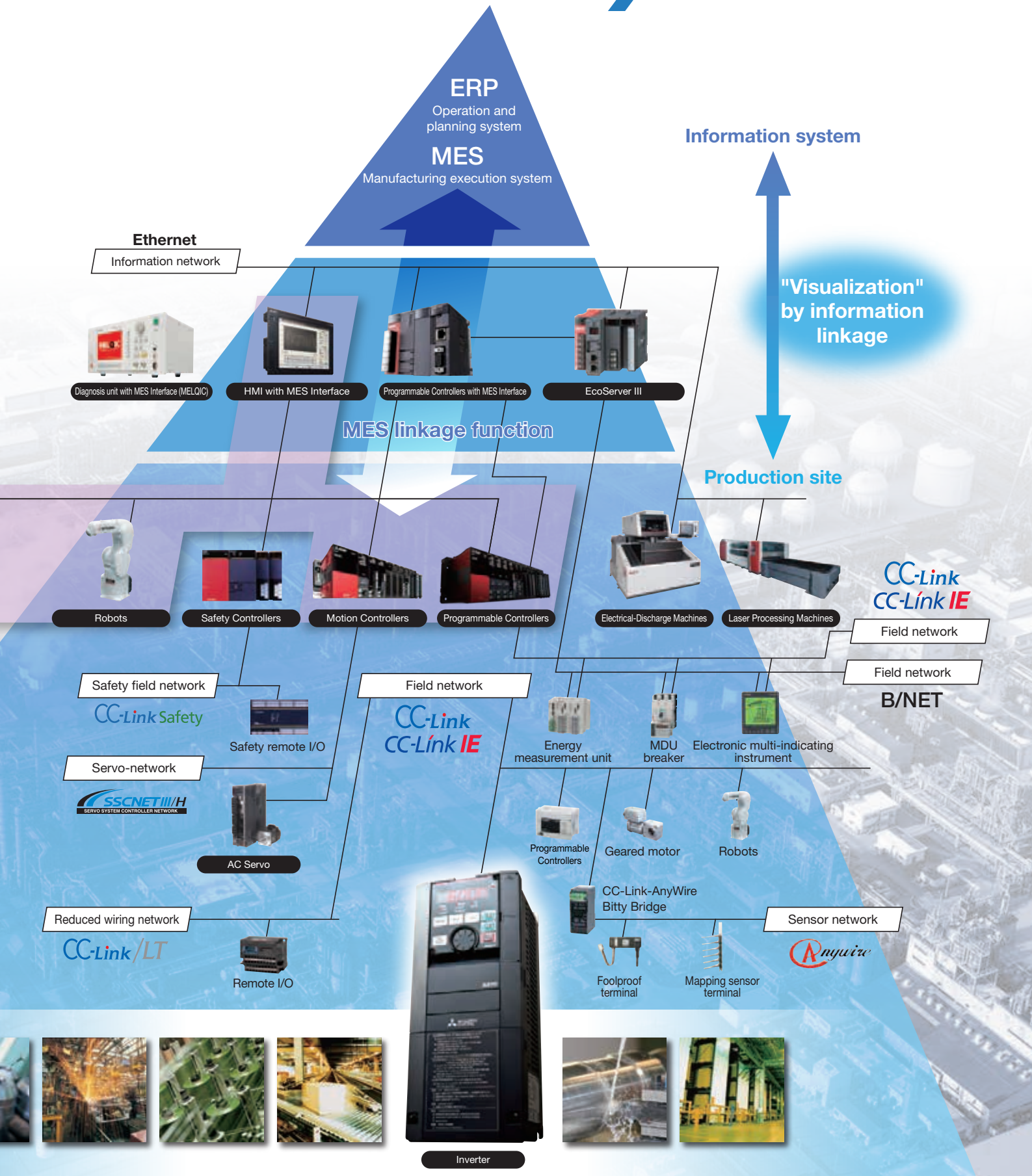

## [ Related Factory Automation Products ]

PLC

MELSEC iQ-R Series



Revolutionary, next generation controllers building a new era in automation

- ◎High-speed, high-accuracy multiple CPU control system based on the iQ Platform
- ◎New high-speed system bus and inter-module sync realizes improved productivity and reduced TCO\*
- ◎Reducing development costs through intuitive engineering (GX Works3)
- ◎Robust security features (such as security key authentication, IP filter)

Product Specifications

Program capacity	40K steps to 1200K steps
LD instruction speed	0.98 ns
Available modules	I/O, analog, high-speed counter, positioning, simple motion, network module
Control system architecture	Rack-mounted modular based system
Supported networks	Ethernet, CC-Link IE Control Network, CC-Link IE Field Network, CC-Link, RS-232, RS-422/485

\*Total Cost of Ownership

Programmable Controller | MELSEC-L Series



“Light & Flexible” condensing various functions easily and flexibly.

- ◎CPU equipped as a standard with various functions including counter, positioning and CC-Link.
- ◎The base-less structure with high degree of freedom saves space in the control panel.
- ◎Easily confirm the system status and change the settings with the display unit.
- ◎Ten models are available in program capacities from 20 k steps to 260 k steps.

Product specifications

Program capacity	20 k steps/60 k steps/260 k steps
Number of input/output points [X/Y]	1024 points/4096 points
Number of input/output device points [X/Y]	8192 points
Basic instruction processing speed (LD instruction)	60 ns/ 40 ns/ 9.5 ns
External connection interface	USB, Ethernet, RS-232, SD memory card, CC-Link (L26CPU-BT/PBT)
Function modules	I/O, analog, high-speed counter, positioning, simple motion, temperature control, network module
Unit expansion style	Base-less structure
Network	Ethernet, CC-Link IE Field network, CC-Link, CC-Link/LT, SSCNETIII(/H), RS-232, RS-422

Programmable Controller | MELSEC-F Series



All-in-One Micro Programmable Controller equipped with all necessary functions in a compact body

- ◎Supporting small-scale control from 10 points to 384 points (using CC-Link) with an outstanding cost performance.
- ◎Wide range of options available for additional functions required by your system.
- ◎Easy to use and highly reliable. More than 12 million units have shipped worldwide. (April 2013)
- ◎Small-scale control is available in various networks such as CC-Link, Ethernet, and MODBUS.

Product specifications

Program capacity	16k steps (FX <sub>3S</sub> ) to 64 k steps (FX <sub>3U</sub> /FX <sub>3UC</sub> )
Number of input/output points	10 points (FX <sub>3S</sub> ) to 384 points (FX <sub>3U</sub> /FX <sub>3UC</sub> with CC-Link)
Basic instruction processing speed	0.21 μs (FX <sub>3S</sub> ) to 65 ns (FX <sub>3U</sub> /FX <sub>3UC</sub> )
External connection interface	RS-422, USB (FX <sub>3S</sub> /FX <sub>3U</sub> /FX <sub>3UC</sub> /FX <sub>3GE</sub> only), Ethernet (FX <sub>3GE</sub> only), CC-Link/LT (FX <sub>3UC</sub> -32MT-LT(-2) only)
Built-in functions	I/O, high-speed counter input, positioning pulse output, analog (FX <sub>3GE</sub> only)
Extended functions	I/O, analog, temperature control, high-speed counter, positioning, network
Unit expansion style	Backplane-less design
Network	Ethernet, CC-Link, CC-Link/LT, SSCNETIII, CANopen, J1939, RS-232C, RS-422, RS-485, MODBUS

## HMI

## Graphic Operation Terminal GOT2000 Series GT27 Model

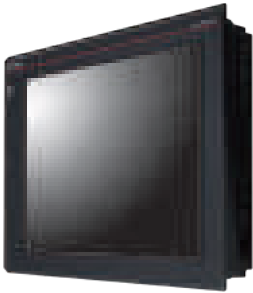

To the top of HMIs with further user-friendly, satisfactory standard features.

- ◎ Comfortable screen operation even if high-load processing (e.g. logging, device data transfer) is running. (Monitoring performance is twice faster than GT16)
- ◎ Actual usable space without using a SD card is expanded to 128MB for more flexible screen design.
- ◎ Multi-touch features, two-point press, and scroll operations for more user-friendliness.
- ◎ Outline font and PNG images for clear, beautiful screen display.

## Product Specifications

Screen size	15", 12.1", 10.4", 8.4"
Resolution	XGA, SVGA, VGA
Intensity adjustment	32-step adjustment
Touch panel type	Analog resistive film
Built-in interface	RS-232, RS-422/485, Ethernet, USB, SD card
Applicable software	GT Works3
Input power supply voltage	100 to 240VAC (+10%, -15%), 24VDC (+25%, -20%)

## AC Servo

## Mitsubishi General-Purpose AC Servo MELSERVO-J4 Series



Industry-leading level of high performance servo

- ◎ Industry-leading level of basic performance: Speed frequency response (2.5kHz), 4,000,000 (4,194,304p/rev) encoder
- ◎ Advanced one-touch tuning function achieves the one-touch adjustment of advanced vibration suppression control II, etc.
- ◎ Equipped with large capacity drive recorder and machine diagnosis function for easy maintenance.
- ◎ 2-axis and 3-axis servo amplifiers are available for energy-conservative, space-saving, and low-cost machines.

## Product Specifications

Power supply specifications	1-phase/3-phase 200V AC, 1-phase 100V AC, 3-phase 400V AC
Command interface	SSCNET III/H, SSCNET III (compatible in J3 compatibility mode), CC-Link IE Field Network interface with Motion, pulse train, analog
Control mode	Position/Speed/Torque/Positioning function/Fully closed loop
Speed frequency response	2.5kHz
Tuning function	Advanced one-touch tuning, advanced vibration suppression control II, robust filter, etc.
Functional safety	Conforms to functions of IEC/EN 61800-5-2, STO: Category 3 PL d, SIL 2 Conforms to Category 4 PL e, SIL 3 by a combination with MR-D30 functional safety unit
Compatible servo motor	Rotary servo motor (rated output: 0.05 to 55kW), linear servo motor (continuous thrust 50 to 3000N), direct drive motor (rated torque: 2 to 240N·m)

## AC Servo

## Mitsubishi General-Purpose AC Servo MELSERVO-JE Series



High performance and easy to use servo system for all machines

- ◎ Easy To Use: The advanced one-touch tuning function enables servo adjustment with one-touch ease without a personal computer.
- ◎ High Performance: Class top-level basic performance including speed frequency response of 2.0kHz.
- ◎ Global Standard: Digital input/output is compatible with both sink and source type connections as a standard.

## Product specifications

Power supply specifications	1-phase/3-phase 200V AC
Command interface	Pulse train, analog
Control mode	Position/speed/torque
Speed frequency response	2.0kHz
Tuning function	Advanced one-touch tuning, advanced vibration control II, robust filter, etc.
Compatible servo motor	Rotary servo motor (rated output: 0.1 to 3kW)

[ Related Factory Automation Products ]

Three-Phase Motor

High Performance Energy-Saving Motor

Super Line Premium Series

SF-PR



Premium Efficiency & Compatible. New Launch of Super Line Premium Series SF-PR Model

- ◎Compared to general efficiency motor SF-JR model, generated loss is reduced by 37% on average, and it is compatible with highly efficient premium IE3.
- ◎Easy replacement is achieved as mounting dimension (frame number) is compatible with general efficiency motor SF-JR model.
- ◎One motor can accommodate different power sources of Japan and the U.S. Three ratings in Japan meet the Top Runner standards, while it corresponds to EISA in the U.S.
- ◎Can be driven by inverters as standard. Advanced magnetic-flux vector control by our FR-A800 achieves steady torque drive up to 0.5Hz.

Product Specifications

Number of poles	2-poles, 4-poles, 6-poles
Voltage·Frequency	200/200/220/230V 50/60/60/60Hz EISA 230V 60Hz or 400/400/440/460V 50/60/60/60Hz EISA 460V 60Hz
Exterior	Totally enclosed fan cooled type (inside, outside installation)
Protection system	IP44
Power transmission system	Motor with 2-poles over 11kW is dedicated for a direct connection. Motors with 4-poles and 6-poles are for both direct and crossed belt connections.
Rotation direction	Counter-clock-wise (CCW) direction viewed from the edge of axis.
Compatible standard	JEC-2137-2000 (Efficiency is compatible with IEC 60034-30.)

Robot

MELFA F Series



High speed, high precision and high reliability industrial robot

- ◎Compact body and slim arm design, allowing operating area to be expanded and load capacity increased.
- ◎The fastest in its class using high performance motors and unique driver control technology.
- ◎Improved flexibility for robot layout design considerations.
- ◎Optimal motor control tuning set automatically based on operating position, posture, and load conditions.

Product Specifications

Degrees of freedom	Vertical:6 Horizontal:4
Installation	Vertical:Floor-mount, ceiling mount, wall mount (Range of motion for J1 is limited) Horizontal:Floor-mount
Maximum load capacity	Vertical:2-20kg Horizontal:3-20kg
Maximum reach radius	Vertical:504-1503mm Horizontal:350-1,000mm

EDM

Wire EDM MV1200R



Next-generation Innovations of our best selling Performance Machine.

- ◎Total running cost reduced up to 42%, which is accounted for 90% by filter, ion exchange resin and power consumption.
- ◎Improved productivity by an innovative automatic wire threading.
- ◎Faster machining is realized with improved power-supply performance.  
(Rz3. 5μm/Ra0. 45μm with 3cuts) (Rz2. 0μm/Ra0. 28μm with 4cuts)

Product Specifications

Model	MV1200R
Machining travel (X×Y×Z)[mm]	(in) 400(15.7)×300(11.8)×220(8.7)(XY axis OPT-drive specifications)
Machining travel (U×V)[mm]	(in) ±60(2.4)×±60(2.4)(OPT-drive specifications)
Max. taper angle [°]	15° (maximum 200mm)(7.9°)
Max. workpiece dimensions [mm]	(in) 810(31.9)×700(27.6)×215(8.5)
Wire diameter [mm]	(in) 0.1(.004) to 0.3(.012)*1
Dielectric fluid	Water
Footprint (W×D)[mm]	(in) 2025(79.7)×2760(108.7)

※1:Φ0.2(0.08) DD guides and Φ1.5(0.06) jet nozzle are standard equipment.

## Laser Processing Machine | CO<sub>2</sub> 2-Dimensional Laser Processing Machine eX-Series

A global standard CO<sub>2</sub> 2-dimensional laser processing systems.

- ◎Productivity has been dramatically enhanced owing to improved acceleration and the latest control technologies exclusive to Mitsubishi Electric.
- ◎2 Action Cutting allows for the entire process, from job setup to parts cutting, to be completed in two simple actions.
- ◎When not processing, the system switches to ECO mode and the resonator stops idling. Minimizes energy consumption, reducing running costs by up to 99%<sup>\*1</sup> during standby.

\*1: Compared to the previous LV-Series with Mitsubishi's designated benchmark shape.

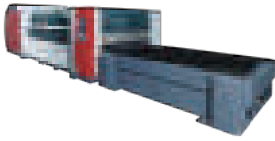

### Product specifications

Model Name	ML3015eX
Drive system	Flying optic (3-axis beam movement)
Stroke (X×Y×Z) [mm]	3100×1565×150
Rapid feedrate [m/min]	X,Y axes: Max. 100; Z-axis: Max. 65
Processing feedrate [m/min]	Max. 50
Positioning accuracy [mm]	0.05 / 500 (X,Y axes)
Repeat accuracy [mm]	± 0.01 (X,Y axes)
Rated output [W]	4500

## Laser Processing Machine for Substrate Drilling | GTW4 Series

Ever-evolving global standard machine

- ◎Newly-developed super-fast galvano and 360W high-power resonator achieve industry-leading productivity.
- ◎Laser beam generated by unparalleled resonator enables stable high-quality copper-direct processing on various surface treatments.
- ◎Single machine can support variety of processing application with Mitsubishi unique powerful laser and optimum beam control.
- ◎Original resonator structure, which can be refreshed by replacing some parts only, realizes low operating cost.



### Product specifications

Model name	ML605GTW4(-H)-5350U / ML605GTW4 (-P) -5350U / ML706GTW4-5350U
Processing workpiece dimensions (mm)	620×560 / 815×662
XY table maximum feedrate (m/min)	50
Laser type	CO <sub>2</sub> laser
Oscillator power (W)	360W
Oscillator set pulse frequency	10 to 10000Hz

## CNC | Mitsubishi CNC M700V Series

High-grade model equipped with advanced complete nano control

- ◎Achieve complete nano control with the latest RISC-CPU and high-speed optical servo network.
- ◎Realize super-high grade processing by combining the complete nano control, state-of-the-art SSS control and OMR control, etc.
- ◎Display of essential information of grouped on three screens to greatly reduce processing setup time with easy operability.
- ◎The M700VW Series with WindowsXPe and M700VS Series with integrated control unit and display type are available.



### Product Specifications

Maximum number of control axes (NC axes + spindles + PLC axes)	16 axes (M720VW/M720VS have 12 axes)
Maximum number of part systems	Machining center system: 2 systems Lathe system: 4 systems
Least command increment	1nm (M720VW/M720VS 0.1μm)
Least control increment	1nm
Maximum program capacity	2,000kB (5,120m)
Maximum PLC program capacity	128,000 steps
Main functions (for machining center)	Simultaneous 5-axis machining, SSS control, high-speed high-accuracy control, tool nose point control, tilt plane machining, etc.
Main functions (for lathe)	Milling interpolation, 2-system simultaneous thread cutting, inter-system control axis synchronization, control axis superimposition, combination control, etc.

## [ Related Factory Automation Products ]

### Low Voltage Circuit Breakers | Mitsubishi WS-V Series Molded Case Circuit Breakers, Earth Leakage Circuit Breakers



Technologies based on long year experience realize more improved performance.

- ◎The new electronic circuit breakers can display various measurement items.
- ◎Improvement of breaking performance with new breaking technology “Expanded ISTAC”.
- ◎Compliance with global standard for panel and machine export.
- ◎Commoditization of internal accessories for shorter delivery time and stock reduction.

Product Specifications.

Frame	32-250A Frame
Applicable standard	Applicable to IEC, GB, UL, CSA, JIS and etc.
Expansion of UL listed product line-up	New line-up of 480VAC type with high breaking performance for SCCR requirement
Commoditization of internal accessories	Reduction of internal accessory types from 3 to 1
Commoditization for AC and DC circuit use	Common use of 32/63A frame in both AC and DC circuit
Compact size for easy to use	Thermal adjustable and electronic circuit breakers are same size as 250AF fixed type
Measuring Display Unit (MDU) breakers	MDU breakers measure, display and transmit energy date to realize energy management.

### Magnetic Starter | MS-T Series



Exceed your expectations.

- ◎10A frame model is over 16% smaller with a width of just 36mm!!
- ◎New integrated terminal covers.
- ◎Reduce your coil inventory by up to 50%.
- ◎Be certified to the highest international levels while work is ongoing to gain other country.

Product specifications

Frame	10 A to 32 A
Applicable standards	Certification to various standards including IEC, JIS, CE, UL, TÜV, CCC.
Terminal cover	Standard terminal cover improves safety, simplifies ordering, and reduces inventory, etc.
Improved wiring	Wiring and operability are improved with streamlining wiring terminal BC specifications.
Operation coil rating	Wide range of operation coil ratings reduces number of coil types from 14 (N Series) to 7 types and simplifies selection.
Option units	Diverse lineup includes Auxiliary Contact Block, Operation Coil Surge Absorber Unit, Mechanical Interlock Unit.

### Low-voltage switch | Mitsubishi Motor Circuit Breaker MMP-T Series



Introducing a Motor Circuit Breaker from Mitsubishi Electric!

- ◎Design smaller panels by using the Motor Circuit Breaker, various options and MS-T Series Magnetic Contactor.
- ◎Prevent secondary damage with Motor Circuit Breaker and Magnetic Contactor combination.
- ◎Streamlined wiring terminal BC specifications (option) contribute to improving your productivity.
- ◎Supports your overseas business with compliance to various International Standards as well as the UL Type E/F combination.

Product specifications

Rated current	0.16 A to 32 A (15 types)
Applicable (compliant) standards	Standard product compliant with various International Standards including IEC, JIS, CCC, TÜV and UL (certified)
Wiring types	Bare wire, rod terminal, Y crimp and round crimp supported
Improvement of wiring	Wiring and operability are improved with connection conductor unit and streamlined wiring terminal BC specifications (option)
Optional units	Auxiliary/Alarm Contact Unit, Short-Circuit Indicator Unit, Line Side Terminal Adapter, Connection Conductor Unit, etc., available
DIN rail mounting	Standard product mountable on rail
Finger protection support	Standard product compliant with IP20 from front side of terminals
Application in North America	Type E/F combination certification acquired. Compatible up to maximum SCCR value 50 kA





# Global network for comprehensive support of

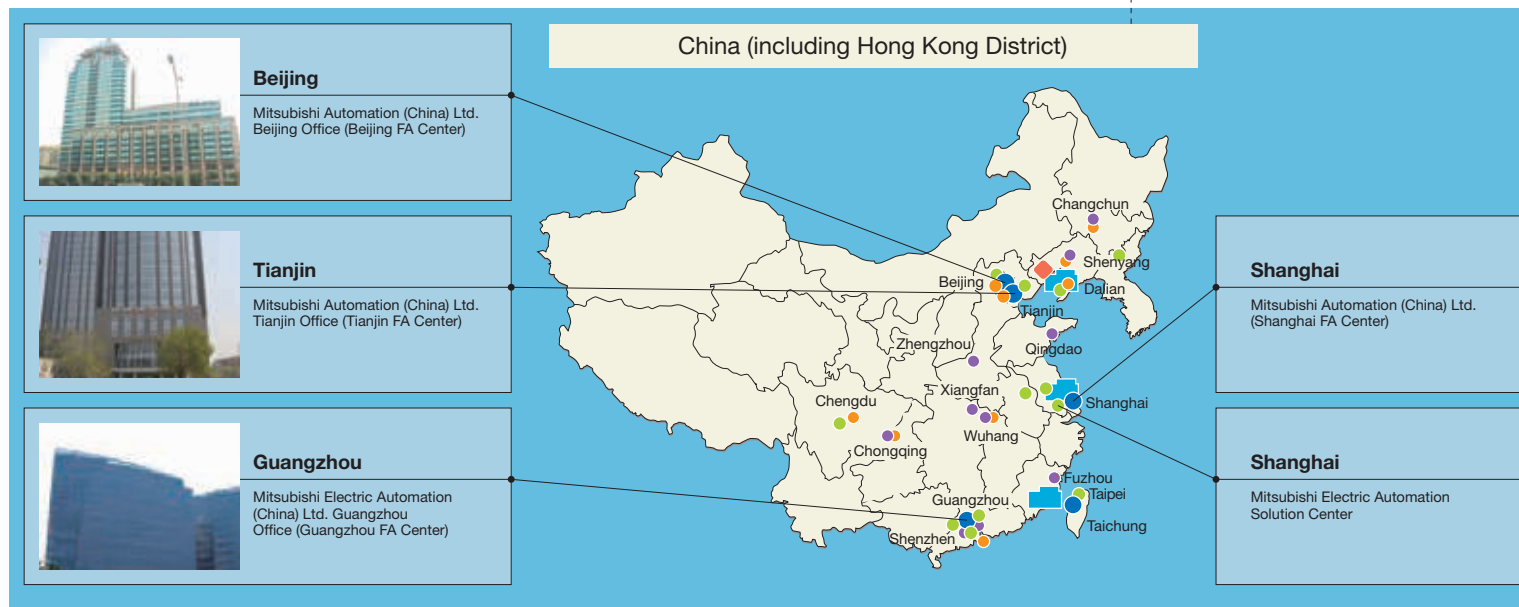
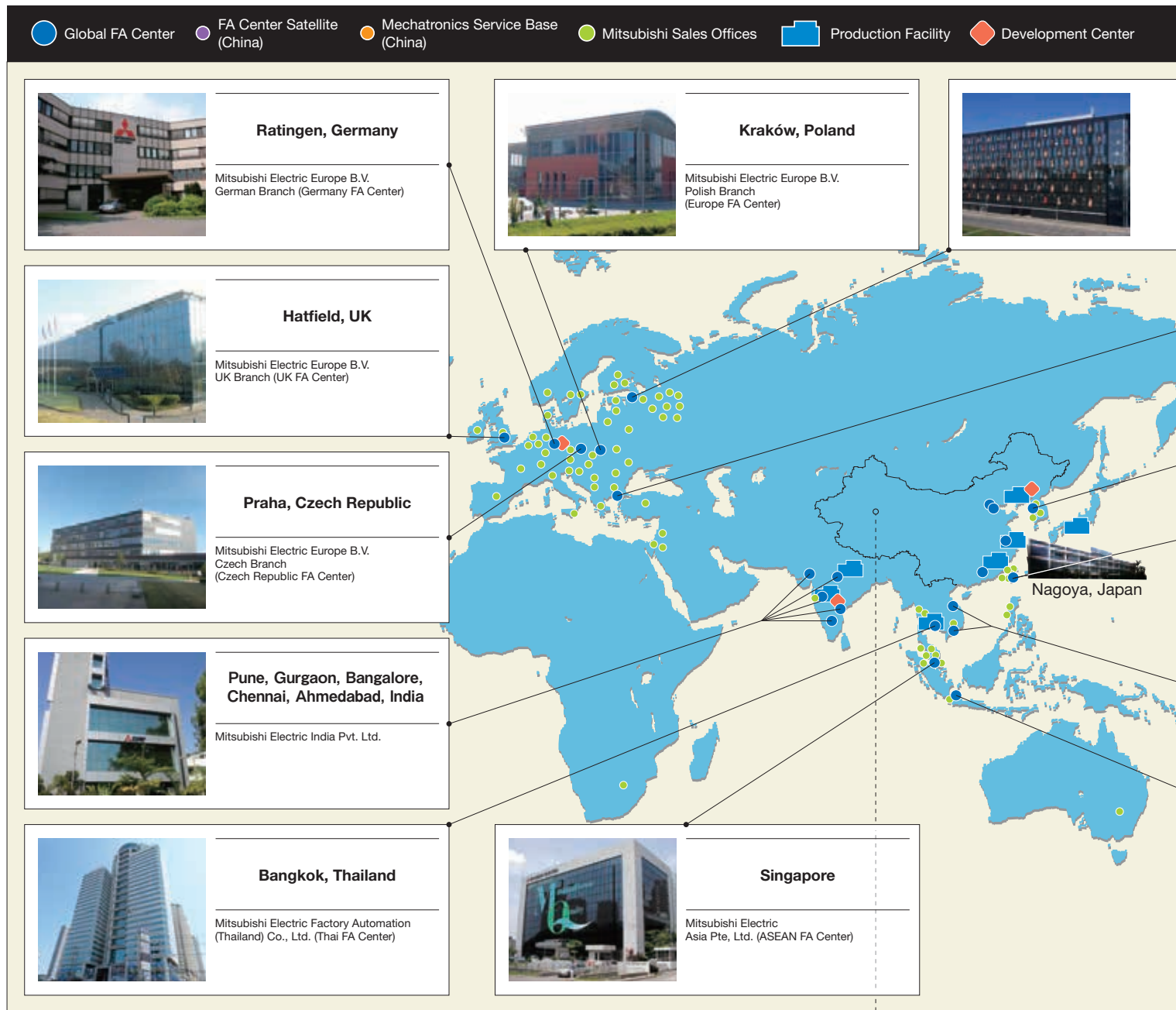

# customers' manufacturing.



Service bases are established around the world to globally provide the same services as in Japan.

**Overseas bases are opened one after another to support business expansion of our customers.**

Overseas bases | As of July 2014 \* Some includes distributors

Area	Our overseas offices		Bases providing our products	Countries (Regions)
		FA Center (Satellite)		
EMEA	11	6 (2)	146	54
China	13	4 (10)	171	1
Asia	21	13	79	10
America	14	4 (0)	130	16
Others	1	0	3	2
<b>Total</b>	<b>60</b>	<b>27 (12)</b>	<b>529</b>	<b>83</b>

Mitsubishi Electric Corporation Nagoya Works is a factory certified for ISO14001 (standards for environmental management systems) and ISO9001 (standards for quality assurance management systems)



# MITSUBISHI ELECTRIC CORPORATION

HEAD OFFICE: TOKYO BLDG., 2-7-3, MARUNOUCHI, CHIYODA-KU, TOKYO 100-8310, JAPAN